

idOil[®] Solar

Solar Powered Oil and Sand Separator Alarm Device



Contents

1	General information about the manual	4
1.1	Markings and symbols	4
1.2	Conformity of the product	4
1.3	Limitation of liability	4
2	Safety and the environment	5
2.1	General safety instructions	5
2.2	Intended use	5
2.3	Transport and storage	5
2.4	Installation and commissioning	5
2.5	Repair	6
2.6	Decommissioning and disposal	6
3	Product description	7
3.1	General	7
3.2	Device operation	8
3.3	System components	8
3.3.1	Solar panel and battery	9
3.3.2	idOil-30 Battery Control Unit	9
3.3.3	idOil-OIL / idOil-OIL-S Oil Sensor	10
3.3.4	idOil-SLU Sludge Sensor	11
3.3.5	idOil-LIQ High Liquid Level Sensor	11
3.3.6	Flashing Beacon	11
3.3.7	Main Power Switch	12
4	Installation	13
4.1	Installing idOil Solar Control Unit	13
4.2	General installation instructions for sensors	13
4.2.1	Installing the idOil-LIQ high liquid level sensor	13
4.2.2	Installing the idOil-OIL / idOil-OIL-S sensor	14
4.2.3	Installing the idOil-SLU sludge sensor	14
5	Connections	16
5.1	Connection diagrams	16
5.1.1	Connection with a single-sensor cable connector	16
5.1.2	Connection with a two-sensor cable connector	17
5.1.3	Connection with a three-sensor cable connector	17
5.2	Explanations of connection diagrams	18
6	Commissioning	19
6.1	Simple commissioning	19
6.2	Commissioning through the browser-based user interface	21
6.2.1	Establishing a WLAN connection	22
6.2.2	System settings	23
6.2.3	Sensor naming and identification	24
7	Operation	27
7.1	Local display and alarms	27

7.2 Resetting an alarm	28
7.3 Using the browser-based user interface	28
7.3.1 Home screen	28
7.3.2 Menu list	29
7.3.2.1 Alarm log	30
7.3.2.2 Inspection	31
7.3.2.3 Inspection log	32
7.3.2.4 Language	33
7.3.2.5 Date and time	34
7.3.3 Settings menu	34
7.3.3.1 Customer data	35
7.3.3.2 Inspection settings	36
7.3.3.3 Alarm settings	37
7.3.3.4 Relay settings	37
7.3.3.5 Software update	39
7.3.3.6 Restoring factory settings	40
7.3.3.7 WLAN settings	41
7.3.3.8 Low power mode settings	42
7.3.3.9 3G settings (idOil-30 3G model only, option)	44
7.4 Operating idOil Solar with mobile phone	45
7.4.1 Setting telephone numbers and telephone number queries (TEL)	45
7.4.2 Name of the device or location (NAME)	46
7.4.3 Time (CLOCK)	47
7.4.4 Timed message interval (TXD)	47
7.4.5 Measurement interval (MI)	48
7.4.6 Listening interval (LI)	49
7.4.7 Operating voltage alarm limit setting (VLIM)	49
7.4.8 Alarm information query (M)	50
7.4.9 Test idOil Solar functions with the sensors	51
8 Maintenance	52
8.1 Functional test	52
8.1.1 Test function	52
8.1.2 Functional test with sensors	52
8.2 Maintenance measures	53
8.3 Troubleshooting	53
9 Technical and safety data	54
10 Appendices	55
10.1 Factory settings for idOil Solar	55
10.2 Connector Flange for idOil Solar	56
10.3 idOil Solar Wiring Diagram	57
10.4 idOil Solar System Diagram	58
10.5 idOil Solar EU Declaration of Conformity	61
10.6 idOil Solar UK Declaration of Conformity	62

1 General information about the manual

This manual is an integral part of the product.

- Please read the manual before using the product.
- Keep the manual available for the entire duration of the product's life span.
- Provide the manual to the next owner or user of the product.
- Please report any errors or discrepancies related to this manual before commissioning the device.

1.1 Markings and symbols

Safety-related markings and symbols



This marking warns of a possible hazard. Failing to observe the safety instructions in question may result in injury or death.



This marking warns of a fault or hazardous situation. Failing to observe the safety instructions in question may result in injury or device breakage.



This marking warns of a possible fault. Failing to observe the safety instructions in question may result in device or system breakage or erroneous operation.



This marking emphasises an issue that requires special attention during installation and when using the device in an explosive atmosphere.

Informative markings and symbols



This marking highlights essential information.



This marking refers to a user measure.

1.2 Conformity of the product

The EU declaration of conformity and the product's technical specifications are integral parts of this document.

All of our products have been designed and manufactured with due consideration to the essential European standards, statutes and regulations.

Labkotec Oy has a certified ISO 9001 quality management system and ISO 14001 environmental management system.

1.3 Limitation of liability

Due to continuous product development, we reserve the right to change these operating instructions.

The manufacturer cannot be held liable for direct or indirect damage caused by neglecting the instructions provided in this manual or directives, standards, laws and regulations regarding the installation location.

The copyrights to this manual are owned by Labkotec Oy.

2 Safety and the environment

2.1 General safety instructions

The plant owner is responsible for the planning, installation, commissioning, operation, maintenance and disassembly at the location.

Installation and commissioning of the device may be performed by a trained professional only.

Protection of operating personnel and the system is not ensured if the product is not used in accordance with its intended purpose.

Laws and regulations applicable to the usage or the intended purpose must be observed. The device has been approved for the intended purpose of use only. Neglecting these instructions will void any warranty and absolve the manufacturer from any liability.

2.2 Intended use

The idOil alarm system is intended for monitoring liquid levels particularly in oil and sand separators.

The system consists of a control unit and connected sensors that have been installed in the oil or sand separator. The sensors can be placed in a zone 0 explosive atmosphere, but the control unit must be positioned in a safe area.

A more specific description of the product's operation, installation and use is provided later in this manual.

The device must be used in accordance with the instructions provided in this document. Other use is counter to the product's purpose of use. Labkotec cannot be held liable for any damage caused by using the device in violation of its purpose of use.

2.3 Transport and storage

Check the packaging and its content for any possible damage.

Ensure that you have received all the ordered products and that they are as intended.

Keep the original package. Always store and transport the device in the original packaging.

Store the device in a clean and dry space. Observe the permitted storage temperatures. If the storage temperatures have not been presented separately, the products must be stored in conditions that are within the operating temperature range.

2.4 Installation and commissioning









If the temperature in the installation environment is expected to exceed +40°C, the temperature tolerance of the supply voltage and relay connection cable must be at least +80°C. Otherwise, any cable that meets the applicable electrical regulations can be used as the supply voltage and relay connection cable.



The internal temperature of the device can be 10°C higher than the ambient temperature. This must be taken into account in the cabling of the device.



The idOil control unit must not be installed in potentially explosive areas, but a sensor connected to it may be installed in potentially explosive atmospheres of zones 0, 1 and 2. In potentially explosive area installations, the national regulations and appropriate standards IEC/EN 60079-25 Intrinsically safe electrical systems "i" and/or IEC/EN 60079-14 Explosive atmospheres - Electrical installations design, selection and erection must all be followed.

-   If it is possible that static electricity can cause hazards in the measurement environment, equipotential bonding must be attended according to the regulations concerning potentially explosive atmospheres. Equipotential bonding is done by connecting all conductive parts to the same potential e.g. in a junction box. Equipotential bonding system must be grounded.
-   The instructions concerning the inspection and maintenance of Ex equipment contained in the standards IEC/EN 60079-17 and IEC/EN 60079-19 should be observed when executing service, inspection or repair procedures in potentially explosive atmospheres.
-   The supply voltage of the device can be batteries / accumulators e.g. via Labkotec Battery Box 10 or an ATEX-certified isolative voltage source according to protection level ia with a output voltage of 11-17 V DC, 10 VA.
If the batteries / accumulators are charged with an external charger, they must be disconnected from the device during charging.
-  See *Technical specifications; Connection values and Appendix; System diagram.*

2.5 Repair

The device may not be repaired or modified without the manufacturer's permission. If the device exhibits a fault, it must be delivered to the manufacturer and replaced with a new device or one repaired by the manufacturer.

2.6 Decommissioning and disposal

The device must be decommissioned and disposed of in compliance with local laws and regulations.

3 Product description

3.1 General

The idOil Solar is a solar-powered alarm and communication unit for monitoring the levels of liquid hydrocarbon, sludge, or high levels in oil and sand separators, in locations where mains power is unavailable.

This user manual includes installation and operating instructions for the following idOil Solar versions:

- idOil Solar 3G
- idOil Solar 3G with a Beacon
- idOil Solar Beacon

Typical applications for the above mentioned idOil Solar versions are illustrated in the following figure.

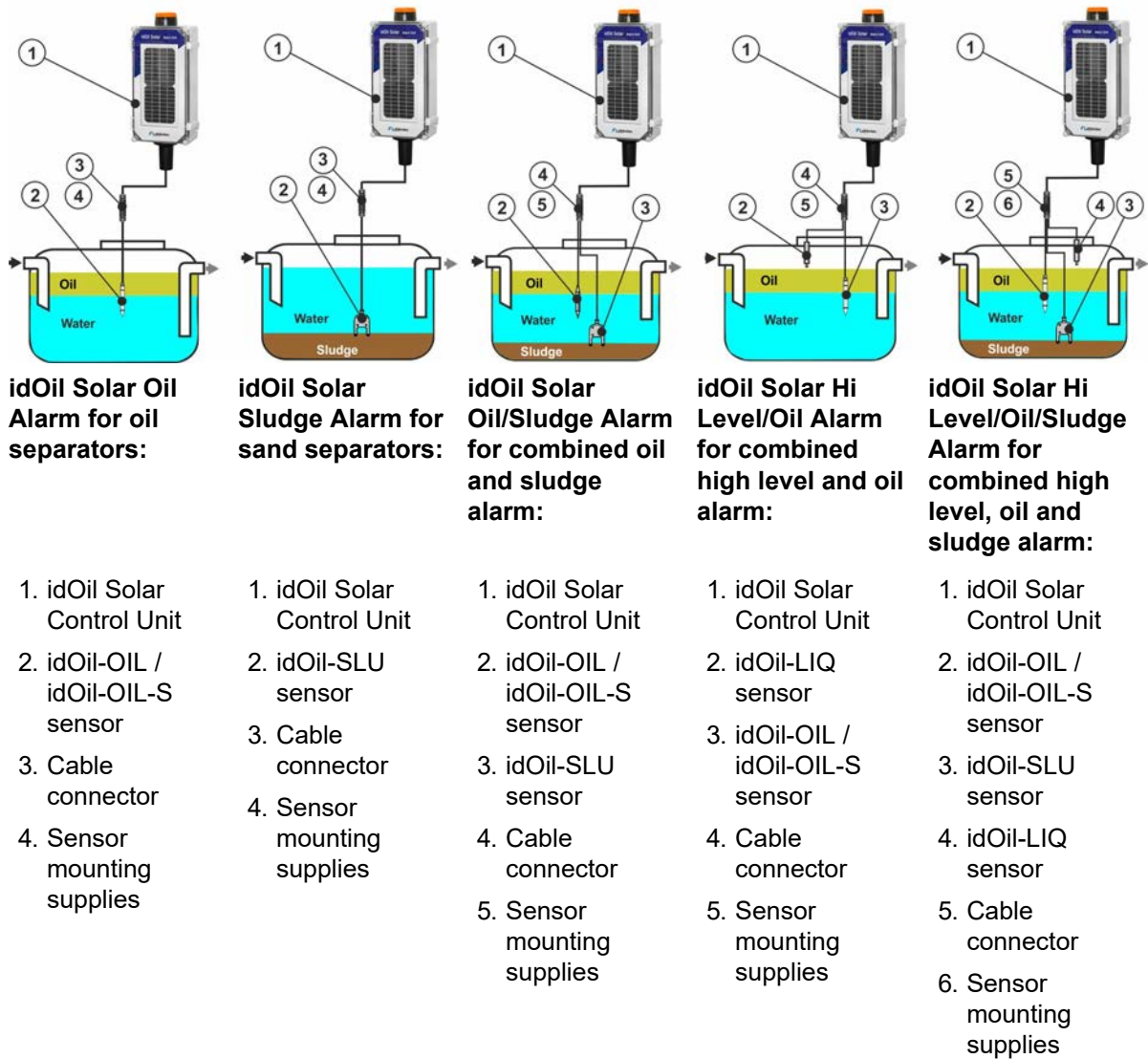

Figure 1. Application examples

3.2 Device operation

The idOil Solar remains deactivated most of the time, which means that it consumes very little power. The device initiates at predetermined measurement intervals, in order to perform the sensor measurements. When equipped with a 3G modem, the device also starts listening at predetermined intervals, to receive any possible setting commands and simultaneously reports measurement values.

In case of an alarm, idOil Solar will either initiate a flashing beacon, or sends a text message (SMS) to pre-set phone numbers, or both. All alarms are also visible locally, in the idOil Solar Control Unit, during the short wake-up period.

The system's power consumption depends on the pre-set measurement and transmission intervals, as well as the number of alarms.

More information about the device operation is available in the *Operation* chapter.

3.3 System components

The idOil Solar Control unit consists of a lockable IP65 polycarbonate housing, containing a solar panel, idOil-30 Battery Control Unit with an in-built charge controller, a lead acid battery (12 V / 7 Ah) and a main switch.

Any combination of fail-safe idOil-sensors, namely the idOil-OIL / idOil-OIL-S oil sensor, idOil-SLU sludge sensor and idOil-LIQ high liquid level sensor, can be connected to the system. The standard sensor cable length of a sensor is 5 meters and extendable to at least 500 meters.

Each alarm unit and sensor combination can be equipped with a 3G communication module, a flashing Xenon beacon or both.

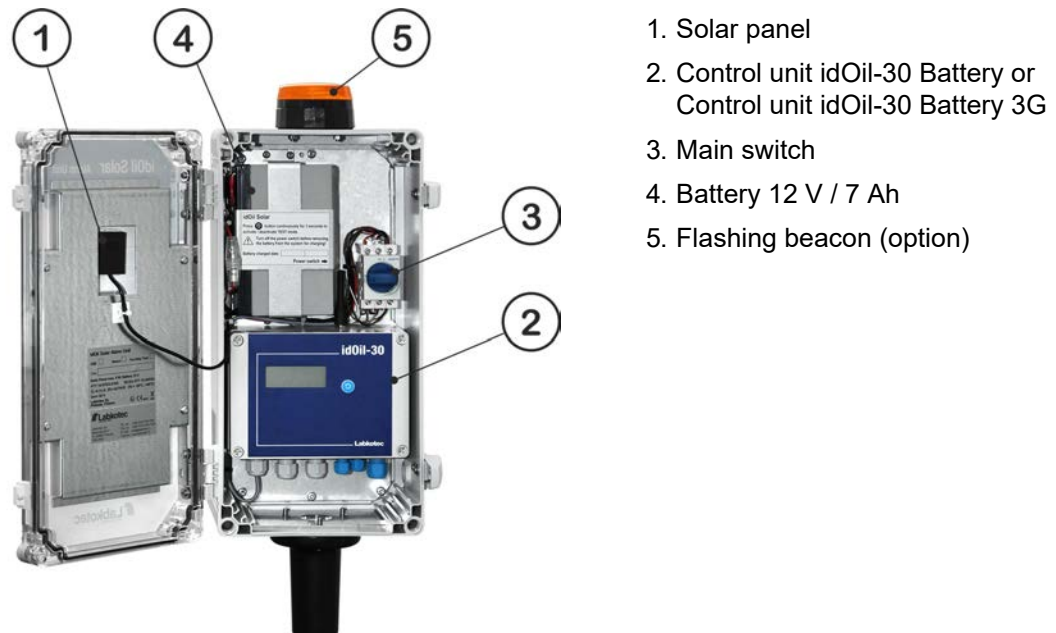



Figure 2. System components - idOil Solar Control unit

3.3.1 Solar panel and battery

The solar panel charges the lead acid battery which powers the idOil-30 alarm unit. Charging of battery is controlled by an idOil-30 built-in solar panel charge controller. In normal use (under factory settings) there is no need to recharge or replace the battery during its natural life time, due to the sophisticated low-power function of the system. Battery life is normally about 5 years.

The idOil Solar will function for at least 6 months without any sunlight. When the idOil Solar is equipped with a xenon beacon, the operational time will be much less in case of an alarm (see Xenon beacon below).

-  Please note that the battery life, and operational time of the idOil Solar depends on many things, such as the amount of solar energy per day and previous days, temperature, battery age and the idOil Solar system settings. Operational times presented in this document are best estimates in particular cases.

3.3.2 idOil-30 Battery Control Unit

The idOil Solar operations are controlled by the idOil-30 Battery or idOil-30 Battery 3G control unit. The idOil-30 takes care of the low-power system functions, measures sensor, and controls the flashing beacon and 3G communication functions. The idOil-30 Battery includes a built-in solar panel charge controller, which takes care of the solar panel and battery charging.

The idOil-30 is an Ex-barrier and power supply unit for the sensors in oil and sand separators.

The idOil-30 Battery 3G version includes a built-in 3G modem and an external 3G antenna. A separate external antenna is also an option, if signal quality is a problem. The user is able to set and modify the settings of the device via text messages (SMS).

The idOil-30 operational settings are pre-set at the factory. The factory settings can be changed via the in-built browser user interface. The browser user interface is accessible via local WLAN connection between the control unit and a smartphone, tablet or laptop. For more information, see idOil-30 installation and operating instructions DOC001699.

The display, test button and interfaces of the idOil-30 control unit are described in the following figure.



1. Local display
2. Test and reset button
3. Lead-through for supply voltage
4. Lead-throughs for relays (2 pcs)
5. Lead-throughs for sensors (3 pcs, blue)
6. 3G antenna (only in 3G version)

Figure 3. idOil-30 Battery - features

3.3.3 idOil-OIL / idOil-OIL-S Oil Sensor



The idOil-OIL / idOil-OIL-S oil sensor is installed into the light liquid storage chamber and gives an alarm when the chamber is filled to a pre-determined level. The sensor is normally fully immersed in water.

Insert the sensor into the separator using the access point provided by the separator manufacturer. The sensor gives an alarm, at the earliest when the upper electrode is in oil, and at the latest when the sensor is totally immersed in a non-conductive liquid. In other words, it is totally separated from the water.

The sensor can be mounted suspended by a cable from the ceiling of the separator. Please check the correct installation depth from the instructions of the oil separator as well.

The function is based on the measurement of the electrical conductivity of the surrounding liquid – water conducts electricity more efficiently than oil.

idOil-OIL oil sensor is for class IIA explosive liquids and idOil-OIL-S oil sensor is for class IIB explosive liquids.

 The idOil-OIL sensor can be installed in a zone 0, 1 or 2 potentially explosive (Ex) area, e.g. oil separator.

3.3.4 idOil-SLU Sludge Sensor



The idOil-SLU sensor is installed in the separator or tank and it gives an alarm when sludge reaches the sensor. The sensor is normally immersed in water.

The idOIL-SLU sensor gives an alarm when there is enough sand or sludge accumulated between the two heads of the sensor. When the sludge layer on the bottom of the separator or settling tank is pretty solid, the correct installation depth can be adjusted, based on the current level. In the event that the level is not clear, a trest period of a couple of days may be useful.

The sensor can be mounted suspended from the ceiling of the separator by cable. Please refer to the oil separator instructions for correct installation depth.

The principle of measurement is ultrasonic. When sludge, sand or other solid particles accumulate between the two sensor heads, the signal strength weakens, an alarm is given.

 idOIL-SLU sensor can be installed in zone 0, 1, or 2 potentially explosive atmospheres.

3.3.5 idOil-LIQ High Liquid Level Sensor



The idOil-LIQ sensor is installed above the separator outlet's upper level. It monitors the total level of the separator, regardless of the existence of the oil layer or sludge in the separator.

The sensor can be mounted suspended from the ceiling of the separator by the cable. Please check the correct installation depth from the oil separator instructions.

The principle of measurement is ultrasonic. The sensor is normally mounted in the air.

 idOIL-LIQ sensor can be installed in a zone 0, 1 or 2 potentially explosive atmosphere.

3.3.6 Flashing Beacon



The idOil Solar can be equipped with a flashing beacon for visual alarms. In case of alarm, a highly visible signal flashes once every 10 seconds.

The beacon is mounted on the top of the idOil Solar enclosure.

The beacon is IP67 rated.

 In case of an alarm, the idOil Solar can operate the flashing the beacon for about 10 days with no sun-light, before the battery becomes discharged. In practise, there is always some solar power available, so the idOil Solar may function much longer with no interruption.

3.3.7 Main Power Switch

The main power switch is located inside of the idOil Solar enclosure (see figure *System components*). Main switch connects and disconnects both battery terminals and the solar panel of the system.

-  The main power switch must be in **ON** position during normal low-power operation. The switch is in **OFF** position during delivery.

4 Installation

4.1 Installing idOil Solar Control Unit

idOil Solar control unit can be wall mounted or installed on a pedestal. The enclosure has mounting holes at each of the corners beneath the mounting holes of the front cover.

For pedestal installation, idOil Solar is equipped with a connector flange (see Appendix *Connector Flange*).

Orientate idOil Solar as accurately as possible towards south and direct sunlight. Check the best possible installation angle (e.g. 68°) at your site. Pedestals or other mounting equipment are not delivered with the device.

All wiring, except sensor cables, of idOil Solar is done already at the factory.



The control unit must be installed in a safe (non-Ex) space.

4.2 General installation instructions for sensors



idOil sensors can be installed in zone 0 explosive atmospheres. Do not remove the sensor markings from the cables or sensor frames.



Read Section *General safety instructions* before installation.



Check the correct installation depth of the sensor in the instructions of the separator in question.

For example, sensors can be installed suspended from their cable (see next figure). Leave a sufficient length of the sensor or extension cable coiled inside the service well, so that you can easily lift the sensor out for inspection and cleaning.

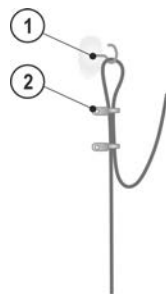

Figure 4. Sensor suspension example

- 1 Suspension hook
- 2 Cable tie



Figure 5. Sensor mounting supplies LMS-SAS5

4.2.1 Installing the idOil-LIQ high liquid level sensor

The sensor is normally in air, and it issues an alarm when the sensing element is submerged in liquid. The sensor is installed at a suitable height above the standard liquid level (L) so that the overflow alarm is activated once the liquid level reaches the sensing element.

Overflow is possible in the following cases, for example:

- if the filter is dirty
- if the automatic closure device is blocked
- or if some other situation causes blockage in the discharge pipe

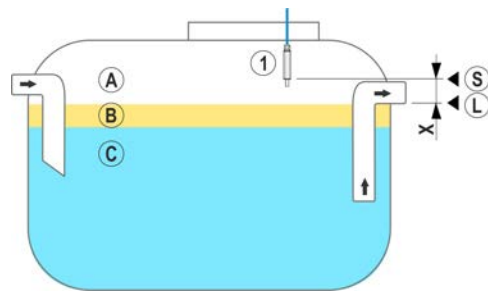

1 idOil-LIQ high liquid level sensor

A Air

B Oil

C Water

L Standard liquid level

S Sensor switching point

X Liquid alarm limit (maximum surface level)

Figure 6. Installing the idOil-LIQ high liquid limit sensor

4.2.2 Installing the idOil-OIL / idOil-OIL-S sensor

The sensor must be submerged at the desired installation depth when the liquid is at the separator's standard liquid level (L).

The exact installation depth depends on the following:

- separator type
- separator shape
- volume and height of the separator's oil compartment

The sensor must always be immersed in liquid. The alarm is activated when the lower surface of the oil layer reaches the alarm switching point (S), i.e. when the sensor's measuring electrode is covered in oil.



The sensor activates the alarm when it is in contact with air. For this reason, the separator must always be filled with water after draining.

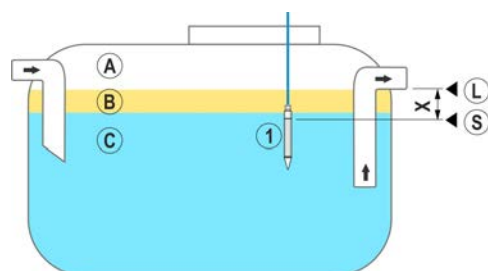

1 idOil-OIL / idOil-OIL-S oil sensor

A Air

B Oil

C Water

L Standard liquid level

S Alarm switching point

X Maximum allowed oil layer thickness

Figure 7. Installing the idOil-OIL / idOil-OIL-S sensor

4.2.3 Installing the idOil-SLU sludge sensor

The sensor issues an alarm on sludge, sand or other solids accumulated at the bottom of the separator.

The sensor's exact installation depth depends on the following:

- separator type
- separator shape
- maximum allowed sludge layer thickness

The sensor must always be immersed in liquid. The alarm is activated when the sludge layer reaches the alarm switching point (S), which is located inside the sensor gap (T).

- i** The sensor activates the alarm when it is in contact with air. For this reason, the separator must always be filled with water after draining.

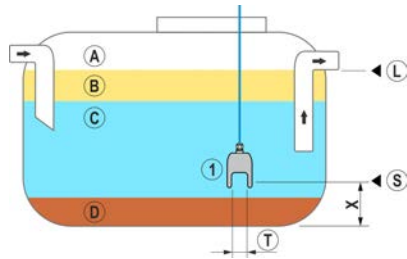

Figure 8. Installing the idOil-SLU sludge sensor

1 idOil-SLU sludge sensor

A Air

B Oil

C Water

D Sludge





L Standard liquid level

S Alarm switching point

X Maximum allowed sludge layer height

T Sensor gap

5 Connections

-  Read Section *General safety instructions* before installation.
-  Read Section *Installation and commissioning* before installation.
-  Make the connections when the device is de-energised.
-  The legends for the connection diagrams can be found in the section following the diagrams.

5.1 Connection diagrams

5.1.1 Connection with a single-sensor cable connector

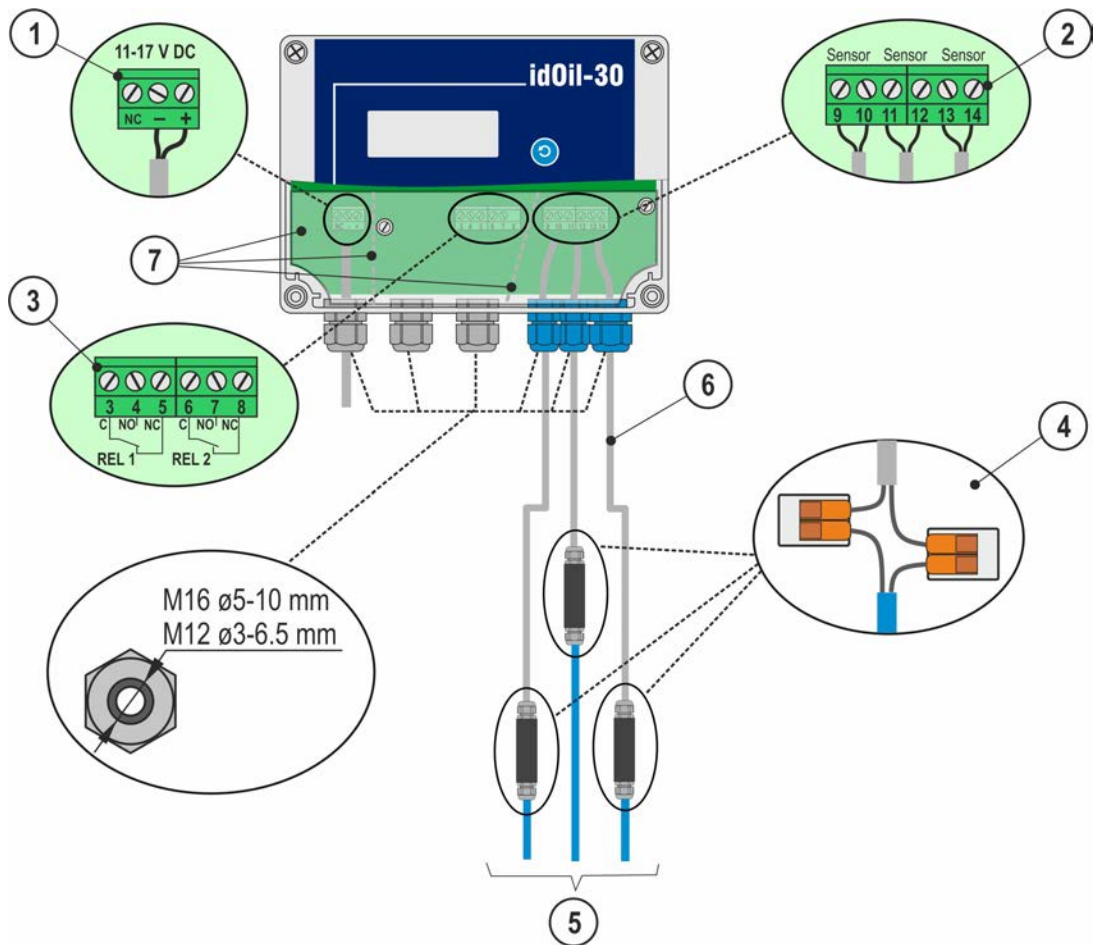

Figure 9. Connection with a single-sensor cable connector

5.1.2 Connection with a two-sensor cable connector

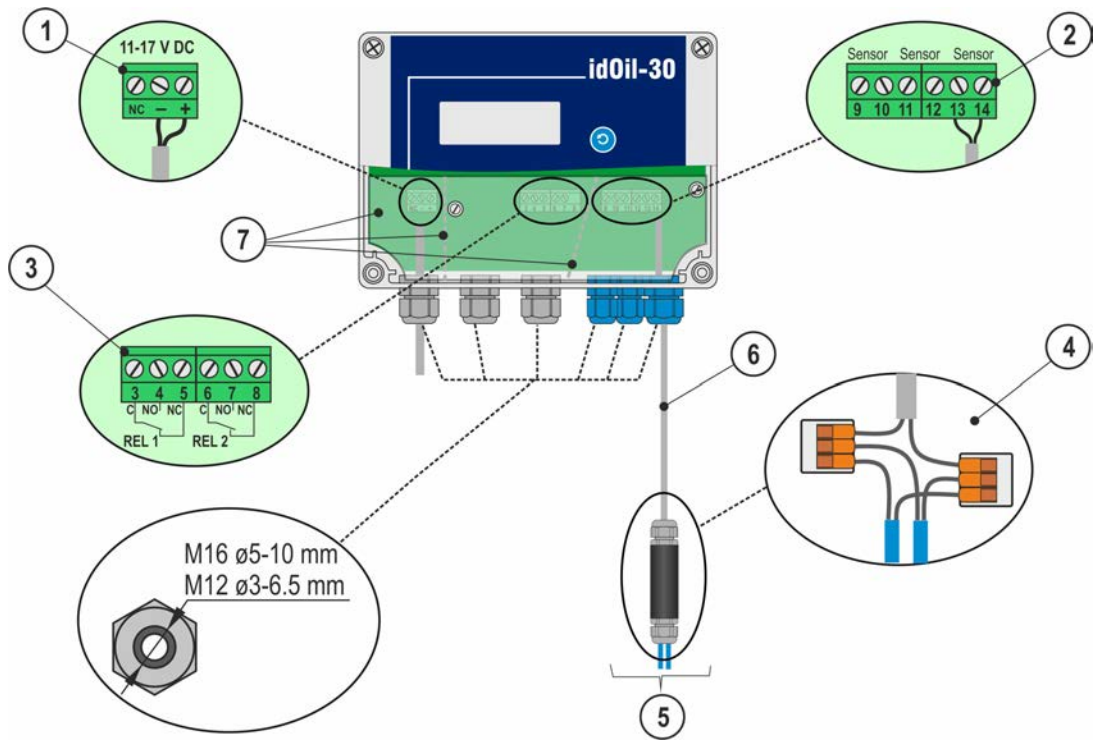

Figure 10. Connection with a two-sensor cable connector

5.1.3 Connection with a three-sensor cable connector

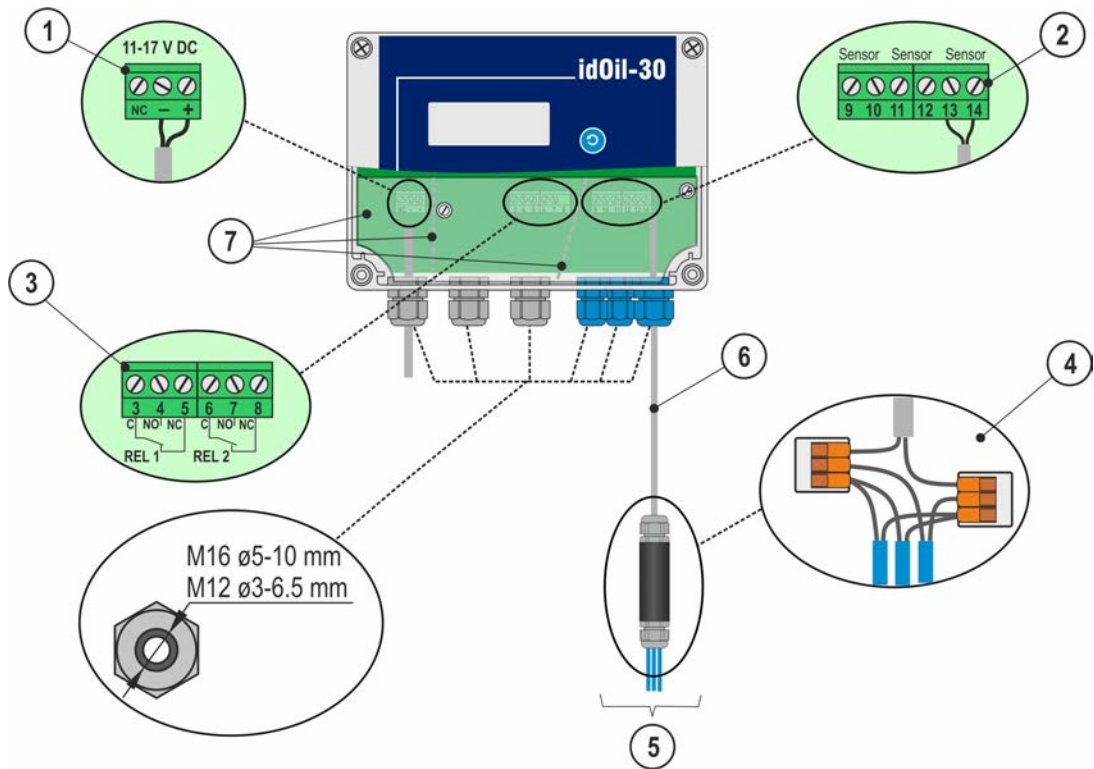

Figure 11. Connection with a three-sensor cable connector

5.2 Explanations of connection diagrams

1 Supply voltage 11–17 V DC e.g. via Labkotec Battery Box 10

- = negative supply voltage

+ = positive supply voltage

Max. supply cable 2.5 mm² (-, +) AWG 13.

2 Sensor connectors

9 = sensor 1, connection 1

10 = sensor 1, connection 2

11 = sensor 2, connection 1

12 = sensor 2, connection 2

13 = sensor 3, connection 1

14 = sensor 3, connection 2



The sensor connection is a polarity-free digital bus, which means that it does not matter which sensor terminal the wires are connected to.

3 Relay outputs

RELAY 1

3 = Relay common contact

4 = Contact that opens in an alarm situation

5 = Contact that closes in an alarm situation

RELAY 2

6 = Relay common contact

7 = Contact that opens in an alarm situation

8 = Contact that closes in an alarm situation



The maximum values presented in the technical specifications must be taken into account.

4 Cable connector:

LCJ1-1 for a single sensor

LCJ1-2 for two sensors

LCJ1-3 for three sensors

5 Sensors

6 Extension cable, e.g. protected, twisted-pair 2 x 0.5 mm², maximum resistance 68 Ohm.

Extra wires and shield must be cut and isolated carefully.

7 Protection plate



The connectors for the external connections are separated with separator walls on the protection plate. The separator walls must not be removed. The protection plate covering the connectors must be reinstalled after connecting the cables.

6 Commissioning

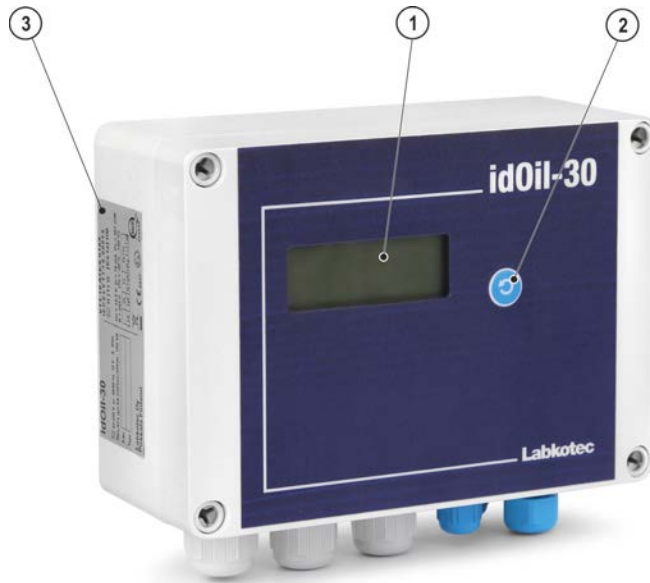

- 1 Display
- 2 Reset and test button
- 3 Type plate with the serial number

Figure 12. User interface description

- i** Most of the idOil Solar parameters are already initialized at the factory. Factory settings are described in *APPENDIX; Factory settings for idOil Solar*.
- i** idOil Solar must be activated in order to commission the system. This is done by pushing the *Test and reset* button of idOil-30 Control Unit for 10 seconds. *Power* switch must be ON.

6.1 Simple commissioning

Ensure that the sensors have been installed and connected in the control unit in accordance with the instructions in the previous paragraphs.

- ▶ Connect power to the control unit.

A message is shown in the control unit display: *NO SENSORS*.



Figure 13. Initial start-up

- ▶ Open the cover of the control unit.
- ▶ Briefly press the sensor identification button (1).

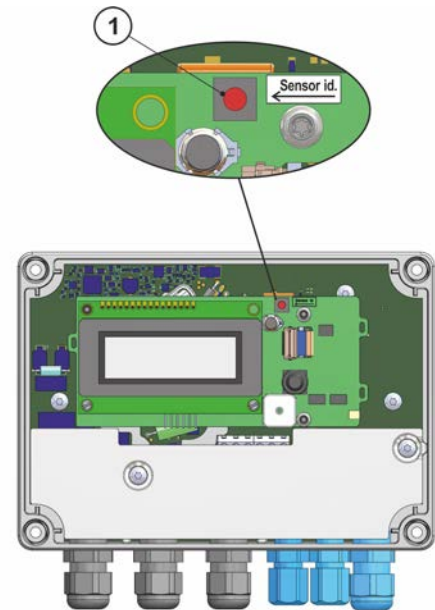

Figure 14. Sensor identification button.

The control unit display shows the message *"Detecting sensors, 0 sensor(s) found"* and three dots begin cycling at the bottom of the display.



Figure 15. Sensor identification.

Depending on how many sensors are connected to the control unit, the display may show the following message, for example: *"Detecting sensors, 3 sensor(s) found"*.



Figure 16. Three sensors found.

Once all sensors have been identified, the display shows the message: *SYSTEM OK*.

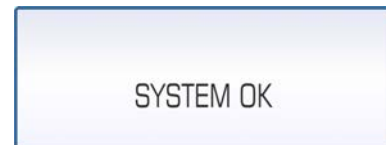

Figure 17. All sensors found.

If the control unit does not identify all connected sensors.

- ▶ Check the sensor connections.
- ▶ After the check, press the sensor identification button again.



The control unit will look for the sensors for approx. 2 minutes, unless it has already found three sensors.

The sensor identification can be stopped by pressing the sensor identification button for 5 seconds.

SIM card installation (idOil-30 3G model only, option).

- ▶ Ensure that the device is de-energised.
- ▶ Open the cover of the control unit and ensure that the connection protection plate is in place!
- ▶ Install Mini-SIM card to SIM holder.
- ▶ Close the cover and connect power to the control unit.

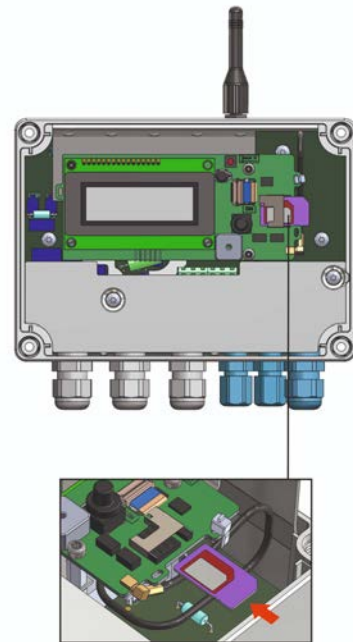

Figure 18. SIM card installation

When the control unit is searching network, there is signal strength bar with X symbol in the upper right corner of the local display.

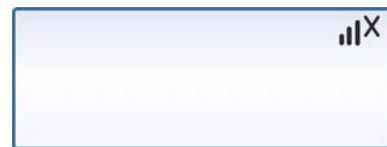

Figure 19 . Device is searching network

When the control unit is found the network, the X symbol disappears and the signal strength bar is left in the upper corner of the local display.

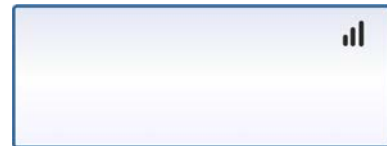

Figure 20 . Device is connected in network

6.2 Commissioning through the browser-based user interface

The commissioning process can also be performed through the control unit's built-in browser-based user interface. For this, you must establish a local WLAN connection between the idOil control unit and a terminal device, such as a smartphone, PC or tablet.

More details on using the browser-based interface is provided in the section *Using the browser-based interface*.

6.2.1 Establishing a WLAN connection

- ▶ Connect power to the idOil control unit.

The display presents the message shown in the figure: *NO SENSORS*.

- ▶ Press the reset button briefly.

A symbol indicating a WLAN network connection is shown in the upper left corner of the display.

If the device power is already on, press the reset button twice; the first push activates the backlight and the second press activates the WLAN connection.



Figure 21. WLAN network on

- ▶ Establish a WLAN connection between the idOil control unit and terminal device as follows:

1. Use the network settings of the terminal device to find the WLAN network provided by the idOil device.
2. Enter the WLAN network password. The password is five zeroes followed by the eight final characters of the device's serial number. The serial number can be found in the idOil device's type plate.
If the serial number is 8540564_1112118J, for example, the WLAN password is 000001112118J.
3. Open the web browser of your terminal device and enter the IP address: 192.168.0.1.

A connection has now been formed between the terminal device and the idOil control unit.

The following sections detail the measures required in connection to initial use.

6.2.2 System settings

The System settings view shown in the figure is opened in the browser.

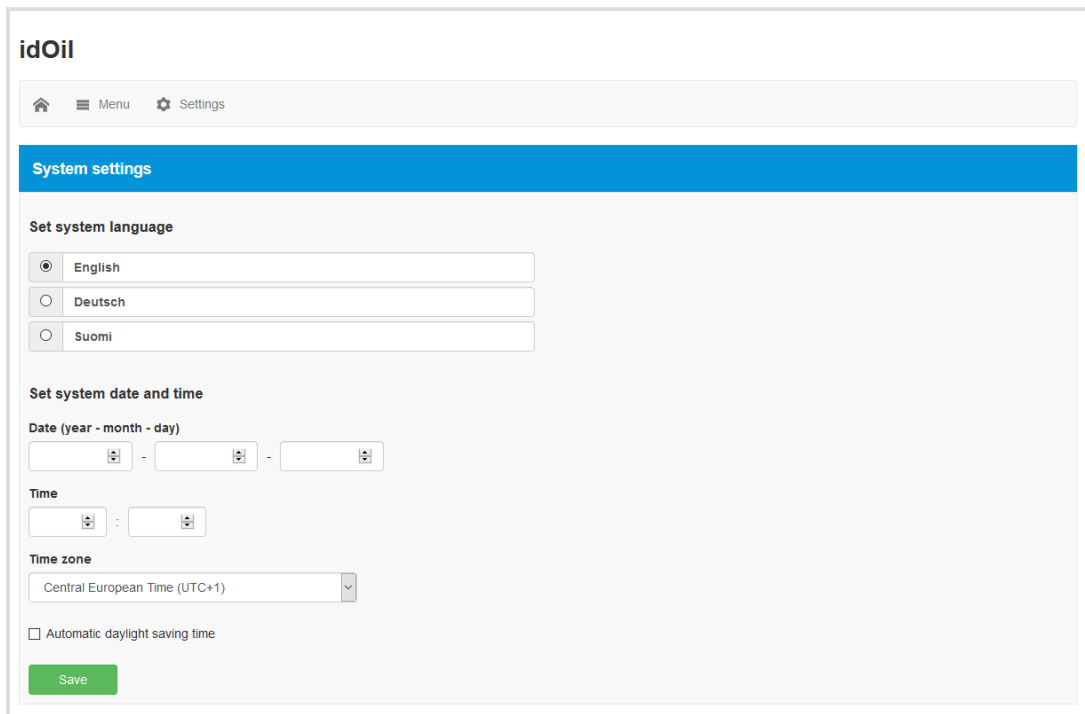

The screenshot shows the 'idOil' system settings interface. At the top, there is a navigation bar with a home icon, a 'Menu' link, and a 'Settings' link. Below this is a blue header for 'System settings'. The main content area is divided into three sections:

- Set system language:** Three radio buttons are present, with 'English' selected. The other options are 'Deutsch' and 'Suomi'.
- Set system date and time:** This section contains two sub-sections:
 - Date (year - month - day):** Three dropdown menus for selecting year, month, and day.
 - Time:** Two dropdown menus for selecting hours and minutes.
- Time zone:** A dropdown menu currently set to 'Central European Time (UTC+1)'.

At the bottom of the settings area, there is an unchecked checkbox labeled 'Automatic daylight saving time' and a green 'Save' button.

Figure 22. System settings

► Do the following:

1. Select the desired *language* as the active language. The default is English.
2. In the *Set system date and time* fields, enter the
 - *Date*: year-month-day
 - *Time*: hours-minutes
3. Select the *Time zone*.
4. If necessary, activate the *Automatic daylight saving time*.
5. Finish by pressing the *Save* button.

6.2.3 Sensor naming and identification

Once the system settings have been set, the control unit switches to sensor identification mode and requests a password as shown in the figure.

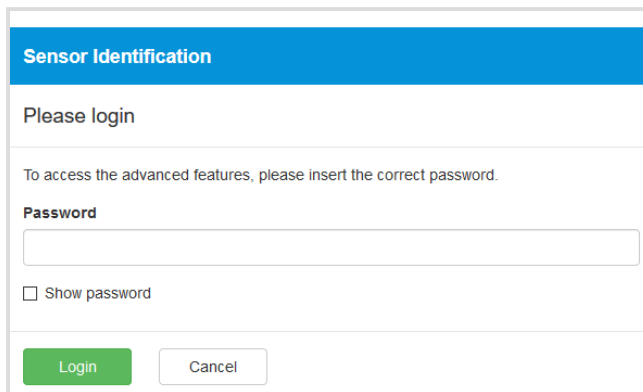

The screenshot shows a web interface titled "Sensor Identification". It contains the following elements:

- A blue header bar with the text "Sensor Identification".
- The text "Please login".
- The instruction "To access the advanced features, please insert the correct password."
- A label "Password" above a text input field.
- A checkbox labeled "Show password" which is currently unchecked.
- Two buttons at the bottom: a green "Login" button and a white "Cancel" button.

Figure 23. Sensor identification; enter password

► Enter 1234 in the password field and press the *Login* button.

If no sensors have been identified before, the view shown below is displayed.



The screenshot shows the idOil dashboard interface. It includes the following elements:

- The "idOil" logo in the top left corner and the date "2018-06-11 09:59" in the top right corner.
- A navigation bar with a home icon, "Menu", "Settings", and a lock icon.
- A blue header bar with the text "Sensor Identification".
- Two buttons: a green "Detect sensors" button and a blue "Help" button.
- A message box at the bottom stating "No sensors found".

Figure 24. Sensor identification; no sensors found.

► Press the *Detect sensors* button. The control unit begins to detect connected sensors.

After detection, the message shown in the figure is displayed. In the example, three sensors are connected.

The screenshot shows the 'idOil' web interface with a navigation bar at the top containing a home icon, 'Menu', 'Settings', and a lock icon. The date '2019-05-17 12:09' is displayed in the top right. Below the navigation bar is a blue header for 'Sensor Identification'. Underneath are two buttons: 'Detect sensors' (green) and 'Help' (blue). The main content area lists three sensors:

- Sensor 1:** Serial number 01742, Sensor type Oil Level sensor. The Description field is empty with a '0 / 55' character count. A green 'Save' button is below.
- Sensor 2:** Serial number 64086, Sensor type High Liquid Level Sensor. The Description field is empty with a '0 / 55' character count. A green 'Save' button is below.
- Sensor 3:** Serial number 53805, Sensor type Sludge Level Sensor. The Description field is empty with a '0 / 55' character count. A green 'Save' button is below.

Figure 25. Sensor identifications; sensors found

► If necessary, enter identifiers for the sensors in the *Description* field and press the *Save* button.

If the control unit does not identify all connected sensors.

- Check the sensor connections.
- Once you have conducted the check, press the *Detect sensors* button again.



The control unit will look for the sensors for approx. 2 minutes, unless it has already found three sensors. After the search, the device shows the number of sensors found in the browser view and the *System OK* message in the control unit display.

The sensor detection can be interrupted by pressing the *Stop detection* button.

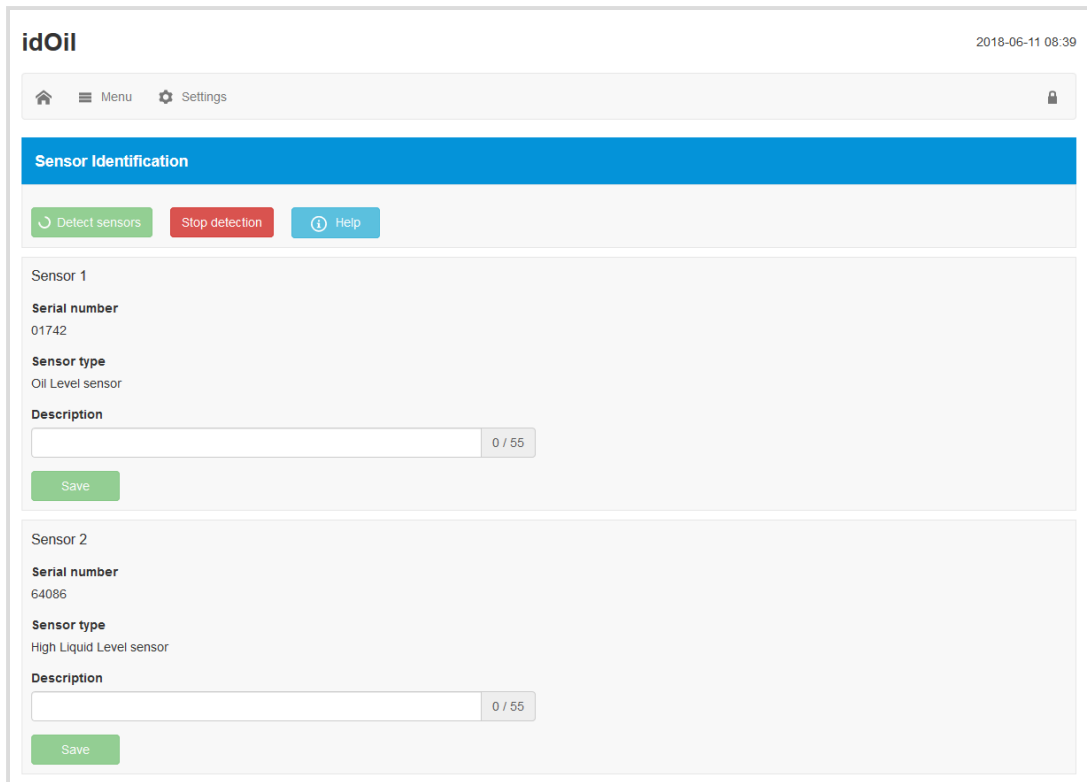

The screenshot shows the 'idOil' web interface. At the top left, there is a home icon, a 'Menu' button, and a 'Settings' button. The top right corner shows the date and time: '2018-06-11 08:39'. Below the navigation bar is a blue header with the text 'Sensor Identification'. Underneath the header are three buttons: 'Detect sensors' (green), 'Stop detection' (red), and 'Help' (blue). The main content area is divided into two sections for 'Sensor 1' and 'Sensor 2'. Each section displays the sensor's serial number, type, and a description field with a 'Save' button.

Sensor ID	Serial number	Sensor type	Description
Sensor 1	01742	Oil Level sensor	
Sensor 2	64086	High Liquid Level sensor	

Figure 26. Sensor identification, stop detection

Once all connected sensors have been identified and individual descriptions have been provided for them:

► Press the home screen button in the upper left corner: 

The idOil separator alarm system is now operational at factory settings.

7 Operation

After installation and commissioning, the idOil separator alarm system functions entirely independently and does not require constant monitoring.

The idOil Solar is fully deactivated for most of the time, which means that it consumes very little power. The device only starts at set measurement intervals to perform the sensor measurements. When equipped with 3G modem it starts also at listening intervals to receive any possible setting commands and at reporting intervals to send measurement values. The power consumption depends on the set measurement and transmission intervals as well as number of alarms. More information about the low-power mode settings is available in chapter *Commissioning*.

All operations are controlled by the idOil-30 Control unit, which is installed inside the idOil Solar enclosure (see *System Components*).

The user can activate the device at any time by pressing the reset/test button briefly. This activates the device for 30 seconds, after which it returns to low power mode. The device's WLAN network is activated when the reset/test button is pressed a second time. In this case, the device stays activated for as long as an external terminal device is connected to its WLAN network. The device returns to low power mode 5 minutes after the end of any active WLAN connection by an external terminal device.

The following chapters describe operation of idOil Solar system through local display, browser-based user interface and text messages.

7.1 Local display and alarms

Local display

The four-row local display in the front panel is normally off. You can activate the display by pressing the reset button once, at which point the display shows the system status as well as possible alarms and faults. In the event of an alarm, the type of the sensor that activated the alarm is shown (high liquid level, oil or sludge). In addition to this, the display can be used to show the customer information specified in the context of commissioning; company and telephone number (not a factor setting).

Alarms

In alarm and fault situations:

-  The device measures sensor status only at the set measurement intervals (e.g. 10 min).

After the alarm delay (10 s):

-  The buzzer sounds an alarm and the display's backlight flashes for 10 s, after which the device enters power saving mode. The relay states are not changed.
- **In a level alarm** the sensor in the separator has detected that the liquid level being monitored has reached the alarm limit (high liquid level, oil or sludge).
- **In a fault alarm** the control unit has detected a fault in the sensor circuit. The monitoring covers the communication between the control unit and sensor as well as short circuits and breaks.

7.2 Resetting an alarm

An alarm can be reset by pressing the test button in the cover.

Resetting an alarm deactivates the buzzer. However, the buzzer is always reactivated for 10 s every 24 hours until the cause for the alarm is eliminated.

Resetting an alarm deactivates the buzzer. However, the buzzer is always reactivated every 24 hours (factory setting) until the cause for the alarm is eliminated.

 The relays do not change their state when an alarm is reset with the reset button.

7.3 Using the browser-based user interface

The following sections describe the use of the idOil browser-based user interface.

 The process of establishing a connection to the browser-based interface is described in the section *Commissioning through the browser-based interface*.

7.3.1 Home screen

The browser-based interface always starts in the home screen shown in the figure below. You can also access the home screen by pressing the  icon in the upper left corner.

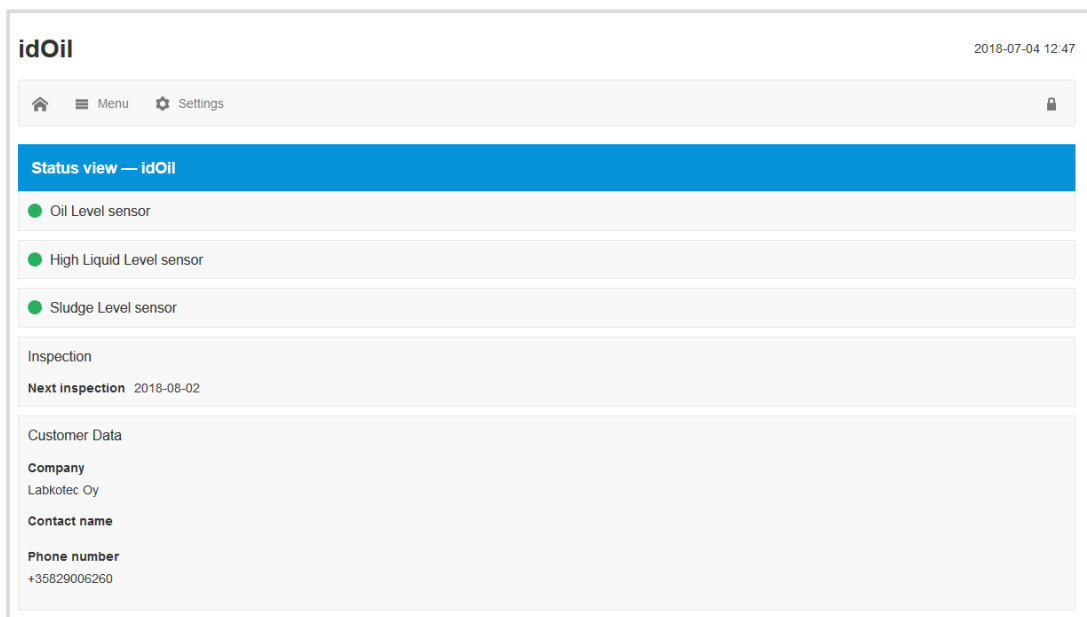



Figure 27. Home screen

The items listed in the following table are shown in the home screen. The menus are described in more detail in the sections below.

idOil	Type name of the control unit
2017-01-04 16:45	Date and time of the device's internal clock
	Home screen button; by clicking this icon, you can return to the home screen
Menu	Selection of menu options
Settings	Settings menu. Requires logging in with the maintenance user password.
	<p>The idOil device features two user levels:</p> <p>Basic user:</p> <ul style="list-style-type: none"> • The upper right corner of the home screen top bar does not show this symbol. • No rights to configure the device, except time and language settings. <p>Maintenance user:</p> <ul style="list-style-type: none"> • The lock system is shown in the upper right corner of the home screen top bar. The user has logged in with the maintenance user password. • The right to configure control unit settings in the Settings menu.
Status view	<p>The status of the sensors connected to the device is shown under the Status view heading:</p> <ul style="list-style-type: none"> • Green means no alarm. • Red means an alarm or fault status in the sensor. The cause of the alarm or fault and the time of the alarm is shown below the sensor.
Inspection	Below the Inspection menu, the device shows either the time of the next scheduled inspection or the latest inspection alarm if the scheduled inspection date is in the past and the alarm has not been reset. See <i>Settings</i> .
Customer data	This section shows the customer and contact information set in the device.

7.3.2 Menu list

The Menu list features the functions shown in the figure below.



Basic users can access the Menu options.



Figure 28. Menu list

7.3.2.1 Alarm log

The alarm log records the times of the alarm and fault situations, the reset times, and the times at which the alarms and faults are eliminated. The following events are recorded in the alarm log:

- Sensor alarm situation.
Note! Alarms caused during maintenance are recorded in the inspection log.
- Sensor fault
- Sensor bus short-circuit
- Test alarm (reset button has been pressed for 3 s)
Note! Alarms caused during maintenance are recorded in the inspection log.
- Power off/on (start and stop time of a power outage)

The buttons at the bottom of the alarm log perform the following functions:

- *Load more items*: Shows previous alarms if all alarms and faults do not fit in the browser window at the same time.
- *Update*: The alarm log view returns to the initial view which shows the latest alarms.
- *Save report*: Saves the alarm log in the .csv format.

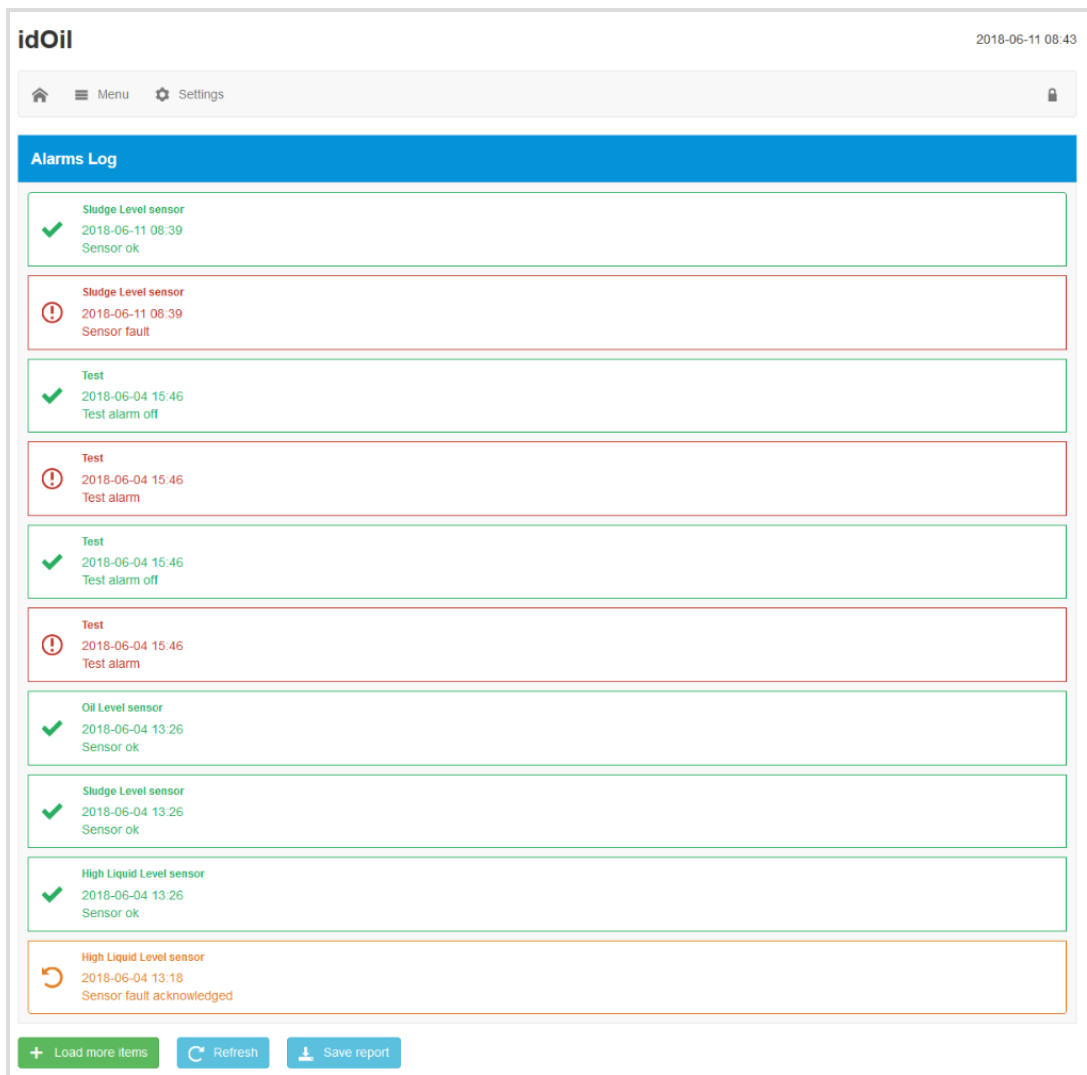

Figure 29. Alarm log

7.3.2.2 Inspection

This function adds an inspection measure in the device's inspection log. Recording inspection measures resets the inspection counter.

- ▶ Press the *Start inspection* button to activate the inspection form.
- ▶ In the *Inspection notes* field, enter the inspection measures conducted and, in the *Inspector name* field, enter your name.
- ▶ End the inspection measure with the *Inspection completed* button. The device will switch to the Inspection log view.

The screenshot shows the 'idOil' web interface. At the top left, the 'idOil' logo is displayed. At the top right, the date and time '2018-06-11 08:44' are shown. Below the header, there is a navigation bar with a home icon, a 'Menu' button, and a 'Settings' button. The main content area is titled 'Inspection' in a blue header. Below this header, there are two buttons: a green 'Start inspection' button with a magnifying glass icon and a blue 'Help' button with an information icon. There are two text input fields: 'Inspection notes' with a character count of '0 / 60' and 'Inspector name' with a character count of '0 / 40'. At the bottom of the form, there are two buttons: a green 'Inspection completed' button and a white 'Cancel' button.

Figure 30. Inspection

The inspection can also be conducted as a quick operation without using the browser user interface. When the inspection alarm is active, the inspection can be conducted with the test operation (see Test function). Press the test/reset button in the front panel for 3 seconds and release the button. The inspection interval counter and the inspection alarm is now reset.

7.3.2.3 Inspection log

The Inspection log view shows the latest inspection note first. Alarms during inspection are shown in the inspection log. These alarms are not shown in the alarm log.

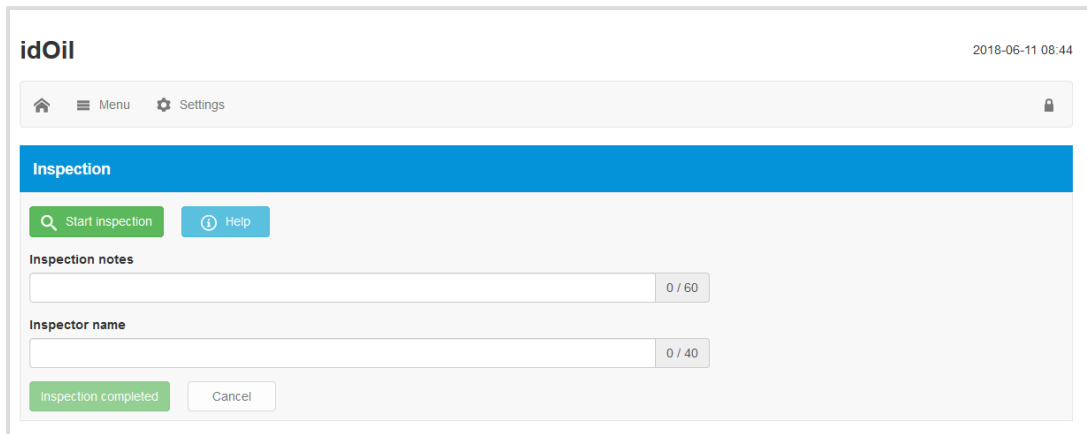
The latest inspection note can be edited but this will not change the time stamp. Old inspection notes can no longer be edited.

► Press the *Save* button after any possible changes.

The buttons at the bottom of the inspection log perform the following functions:

- *Load more items*: Shows prior inspection measures if it is not possible to fit all of them in the browser window at the same time.
- *Update*: The Inspection log view returns to the initial view which shows the latest inspection measures.
- *Save report*: Saves the inspection log in the .csv format.

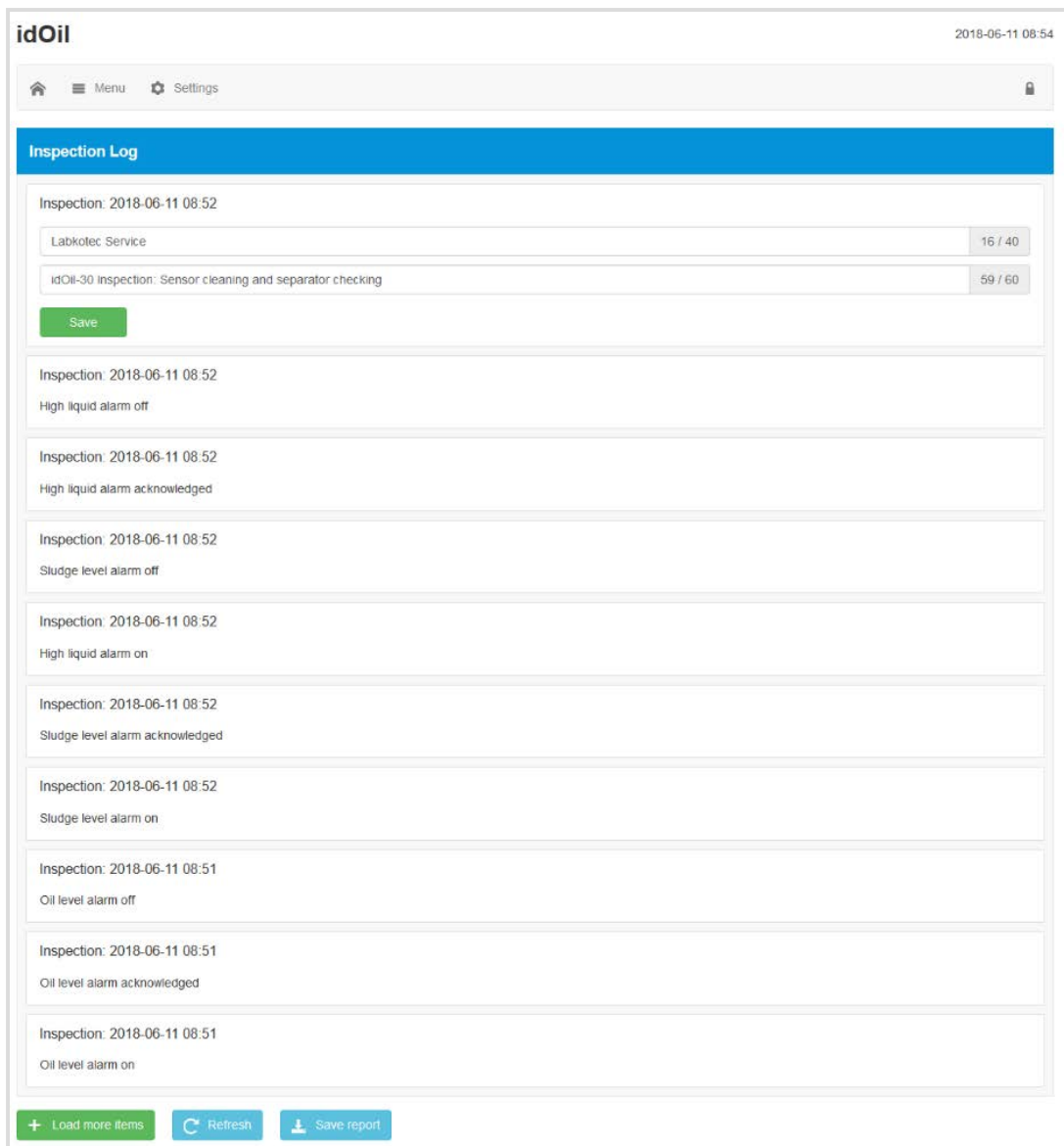

Figure 31. Inspection log

7.3.2.4 Language

You can select one of the supported languages in the Language menu.

► Select the desired language and press the *Select* button.

This will change the language of the browser interface and local display to the selected language.

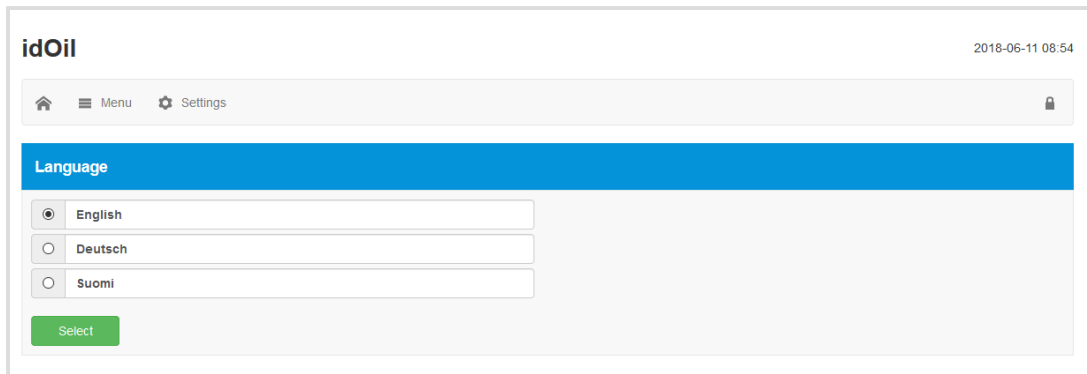

Figure 32. Language selection

7.3.2.5 Date and time

The control unit's date, time, time zone and automatic daylight saving setting can be set and updated in this view.

► Make the necessary changes and press the **Save** button.

The date and time must be set (required information) when the first WLAN connection to the control unit is established.

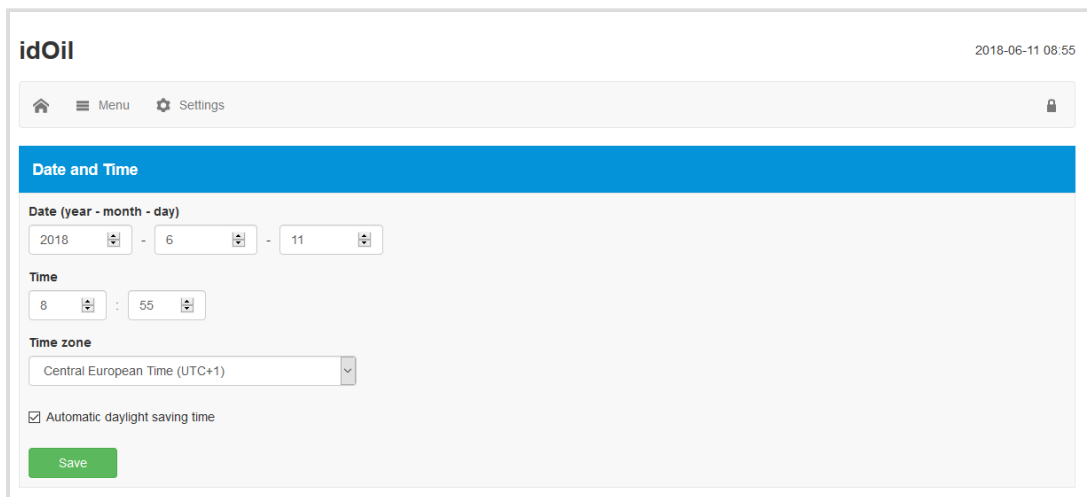



Figure 33. Date and time

7.3.3 Settings menu

The functions in the Settings menu can be used to change the control unit settings. The settings can be accessed with the maintenance user's password.

► Press the Settings menu in the home screen, at which point the device requests a password.

 The maintenance user password is 1234.

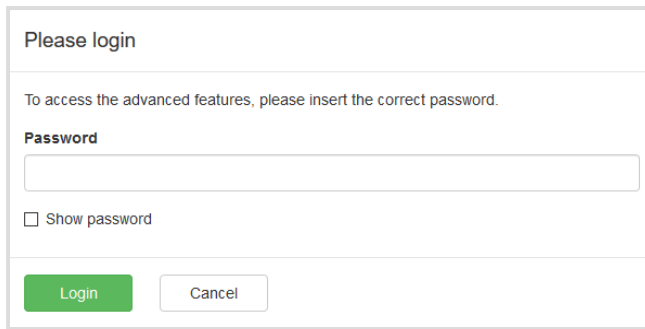

Please login

To access the advanced features, please insert the correct password.

Password

Show password

Figure 34. Password prompt

► Enter the password and press the *Login* button.

The Settings menu features the functions shown in the figure below. The functions are described in more detail in the following paragraphs.

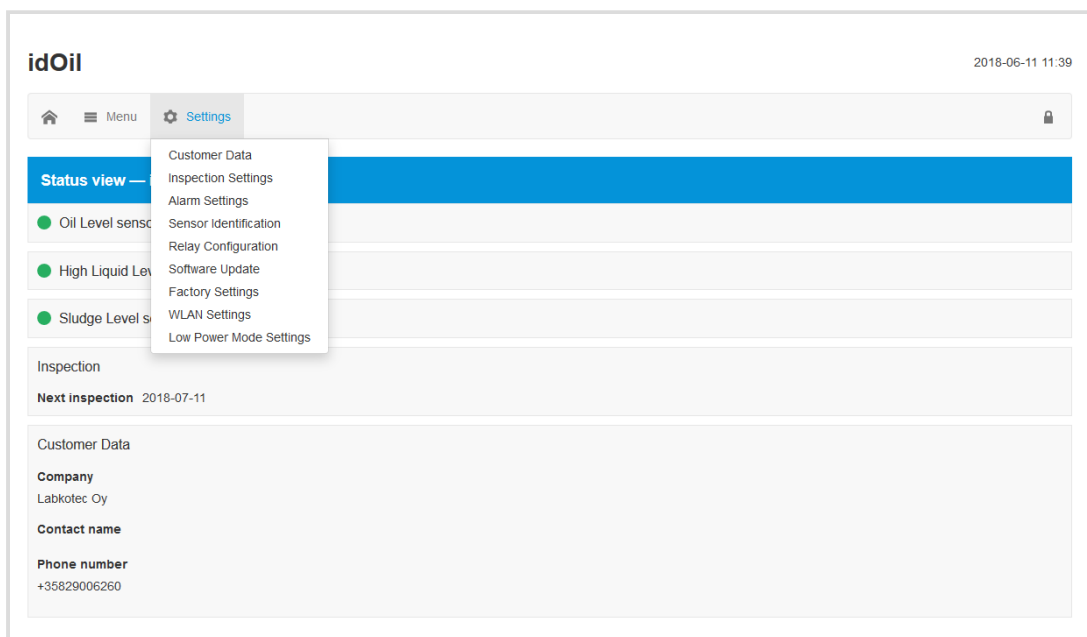
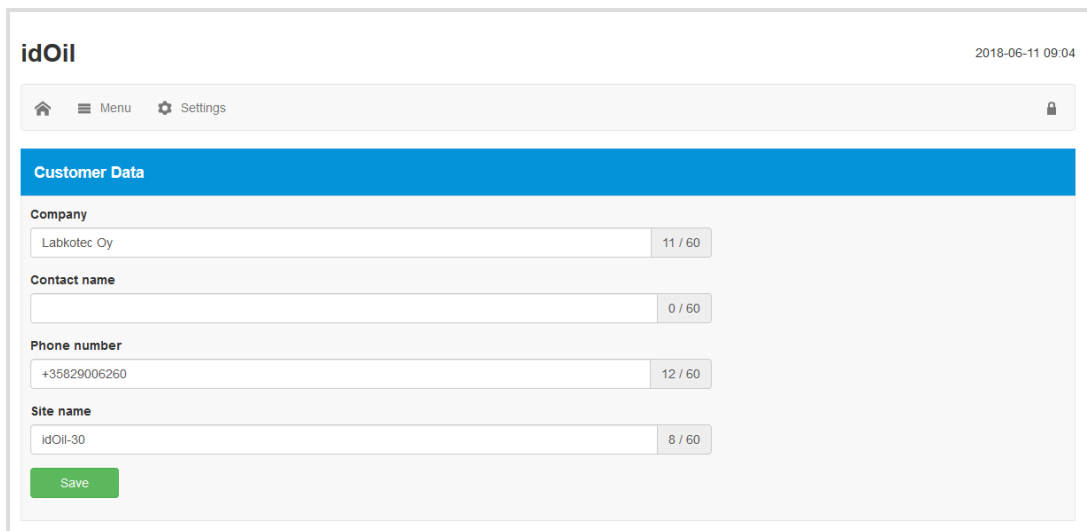

Figure 35. Settings menu

7.3.3.1 Customer data

In the Customer data menu, you can enter the following information in the device:

- **Company:** The name of the device owner, supplier or maintenance company, for example. The name is shown in the home screen and the control unit display. The display shows the first 16 characters.
- **Contact name:** The name of the contact person for the above company, for example. The name is shown in the home screen but not the control unit display.
- **Phone number:** The contact person's phone number. The number is shown in the home screen and the control unit display.
- **Site name:** A unique name can be entered for the device. The name is shown in the home screen, in the *Status viewbar* and the loaded reports, but not the control unit display.



The screenshot shows the 'idOil' web interface. At the top right, the date '2018-06-11 09:04' is displayed. Below the header, there are navigation icons for home, menu, and settings, along with a lock icon. The main content area is titled 'Customer Data' in a blue header. Below this, there are four input fields: 'Company' (containing 'Labkotec Oy', 11/60 characters), 'Contact name' (empty, 0/60 characters), 'Phone number' (containing '+35829006260', 12/60 characters), and 'Site name' (containing 'idOil-30', 8/60 characters). A green 'Save' button is located at the bottom of the form.

Figure 36. Customer data

7.3.3.2 Inspection settings

In the Inspection settings menu, you can set the inspection period counter. You can select between:

- never (factory setting, inspection period not used)
- 1 month
- 3 months
- 6 months
- 12 months

► Select the desired inspection period and press the Save button.

The selection (with the exception of "never") activates the inspection period counter, which will activate the inspection alarm after the selected interval. The time of the maintenance is shown in the home screen (year-month-day) and the control unit display (year-month).

The inspection counter can only be reset once the inspection alarm has been activated. In other words, an inspection cannot be performed before the activation of the alarm (this does not reset the counter).

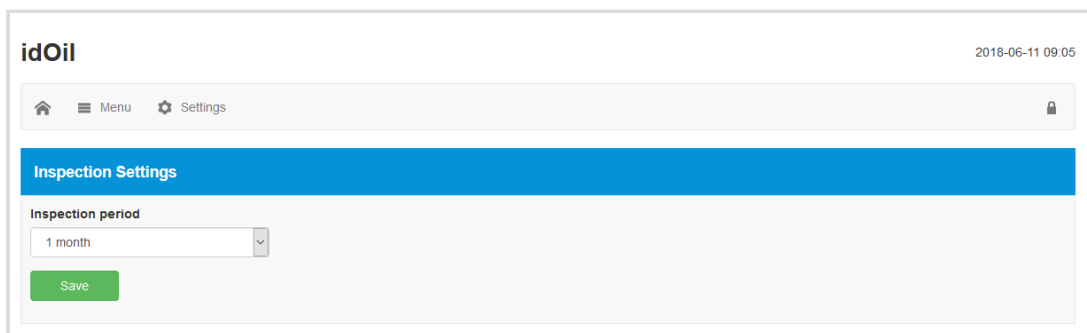

The screenshot shows the 'idOil' web interface. At the top right, the date '2018-06-11 09:05' is displayed. Below the header, there are navigation icons for home, menu, and settings, along with a lock icon. The main content area is titled 'Inspection Settings' in a blue header. Below this, there is a dropdown menu for 'Inspection period' with '1 month' selected. A green 'Save' button is located at the bottom of the form.

Figure 37. Inspection settings

7.3.3.3 Alarm settings

In the Alarm settings menu, you can change the following alarm settings:

- *Alarm buzzer: Off/On.* If *Off* is selected, the buzzer will not sound upon an alarm.
- *Alarm repeat (24 h): Off/On.* If *On* is selected, the alarm will be repeated 24 hours after a reset, if the cause of the alarm has not been eliminated.
- *Alarm delay for sensors.* Delay between sensor detection and the activation of the alarm buzzer and relay. You can use seconds, minutes or hours for the setting.
- *Alarm reset button: Disabled/Enabled.* If *Disabled* is selected, the alarm cannot be reset by pressing the reset button in the front panel of the control unit (i.e. the buzzer will keep sounding the alarm).

The screenshot displays the 'idOil' web interface for alarm configuration. At the top, the 'idOil' logo and the date '2018-06-11 09:06' are visible. A navigation bar includes a home icon, a 'Menu' button, and a 'Settings' button. The main section is titled 'Alarm Settings' and is divided into several functional areas:

- Audio alarm:** A toggle switch is currently turned 'On'.
- Alarm repeat (24 h):** A toggle switch is currently turned 'On'.
- Sensor 1 / Oil Level sensor:** The 'Alarm delay' is set to 10 seconds. A green 'Save' button is located below the settings.
- Sensor 2 / High Liquid Level sensor:** The 'Alarm delay' is set to 10 seconds. A green 'Save' button is located below the settings.
- Sensor 3 / Sludge Level sensor:** The 'Alarm delay' is set to 10 seconds. A green 'Save' button is located below the settings.
- Alarm reset button:** A toggle switch is currently turned 'Enabled'.

Figure 38. Alarm settings

7.3.3.4 Relay settings

The following functions related to relays 1 and 2 can be set in the Relay settings menu:

- *Sensors connected to relays: Off/On.*
- *Relay action in case of alarm and failure: Off/On.*
- *Relay action in case of an inspection warning: Off/On.*
- *Relay return when alarm is reset by pressing the reset button: No/Yes.*

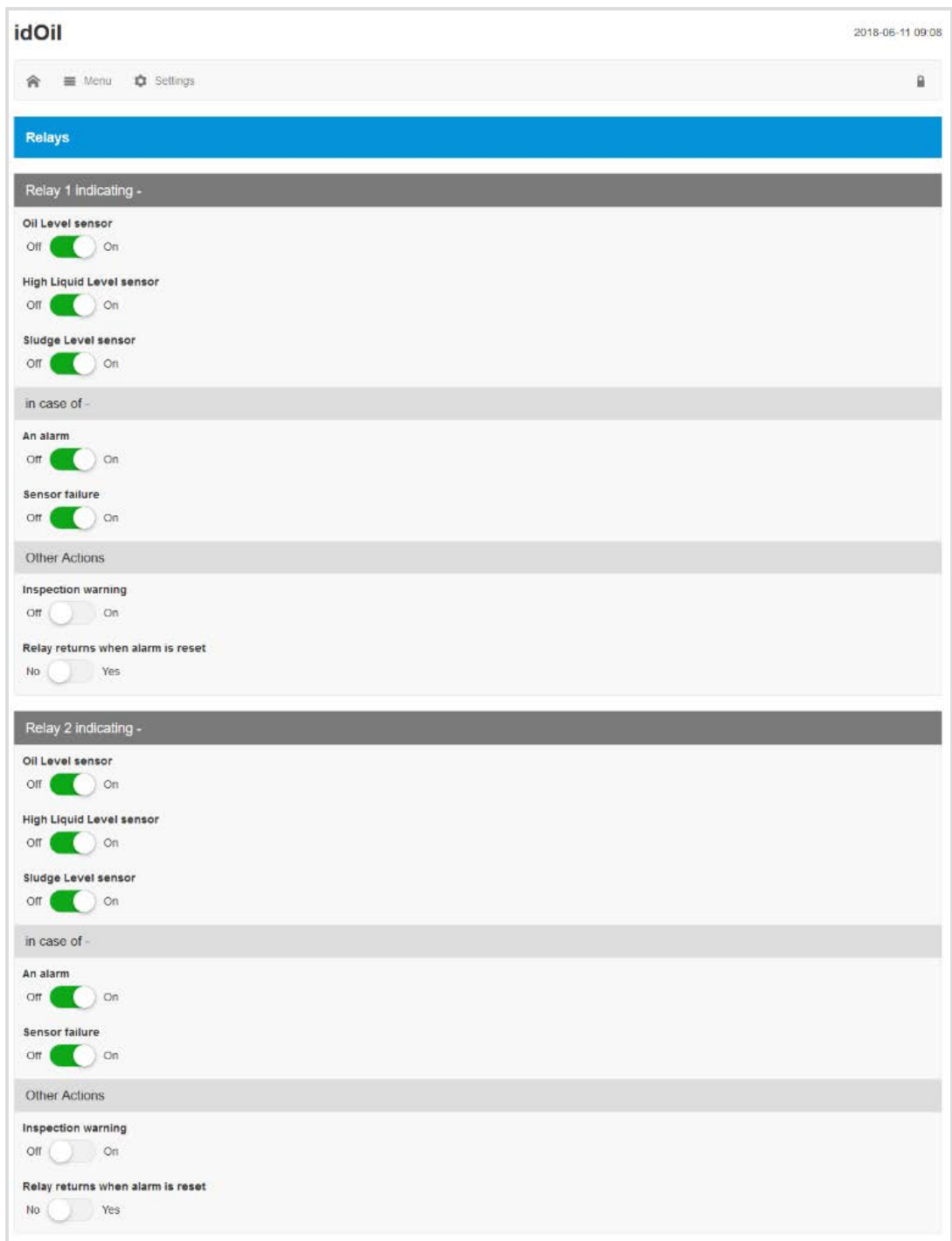

Figure 39. Relay settings

7.3.3.5 Software update

The software of the control unit can be updated through the user interface. The Software update menu shows the current software version and the available language options.



Figure 40. Software update

Upload the new software as follows:

- ▶ Press the *Upload new software package* button.
- ▶ Select the software file to be uploaded (format: ".pkg") from the terminal device memory.

The software will now be uploaded to the control unit. The uploading process may take several minutes.

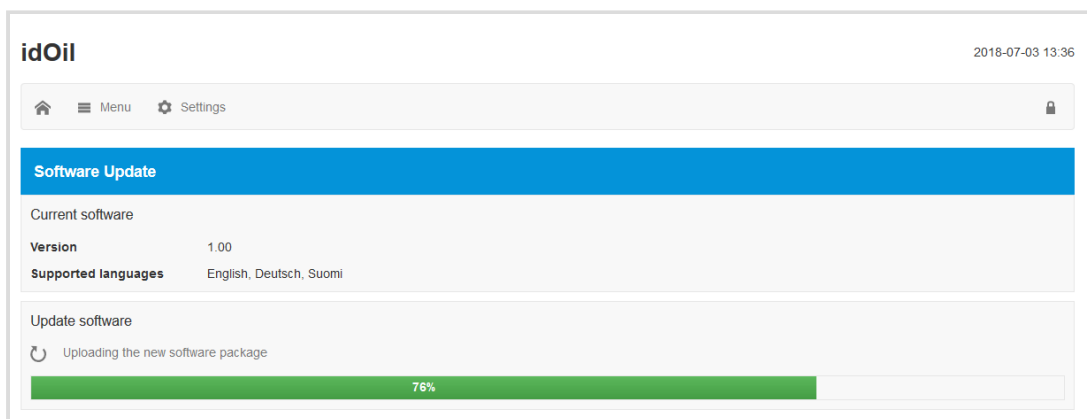

Figure 41. Software upload

Once the software has been uploaded into the control unit's memory, the display will show the current software version and the new version to be updated (see next figure).

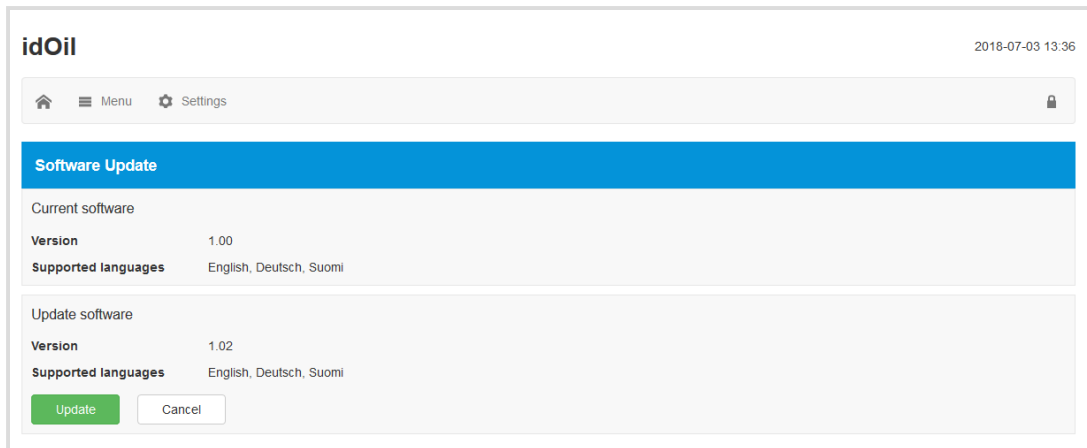

Figure 42. Software uploaded to the control unit

- ▶ Press the *Update* button.

The software update begins and the message in the figure below is shown in the display. The various phases of the software update are presented in the control unit display.

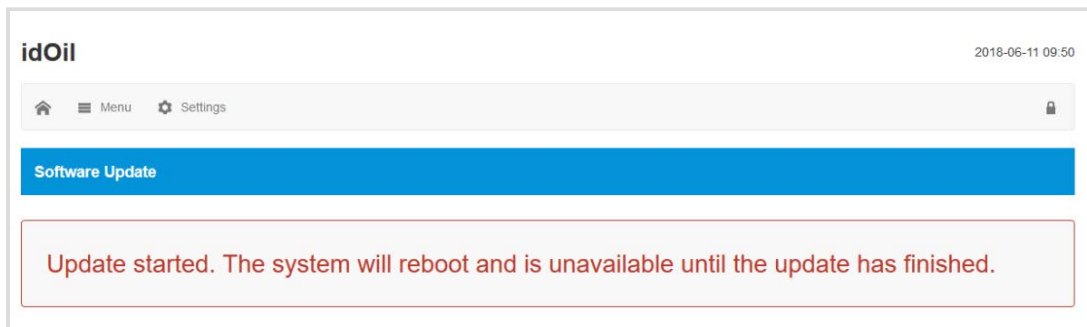

Figure 43. Software update started

Once the programming has been completed, the control unit reboots.

- ⓘ The WLAN connection to the device is lost during a software update.

- ▶ Establish the WLAN connection again according to the instructions in the *Commissioning through the browser-based interface* section.

7.3.3.6 Restoring factory settings

In the Factory settings menu you can restore the control unit's original factory settings.

- ⓘ The factory settings of the idOil device are described in the section *Commissioning*
- ⓘ Restoring the factory settings clears the alarm and maintenance log. The sensors connected to the control unit must also be identified again.

You can restore the factory settings as follows:

- ▶ Check the *Restore factory settings* box and press the *Restore settings* button (see the next figure).

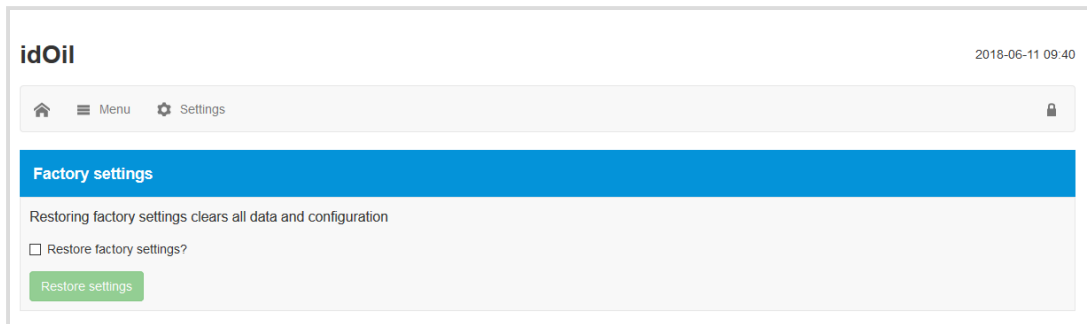

Figure 44. Restoring factory settings

- ▶ Confirm the restoration of the factory settings by pressing *Yes, I want to clear all data* button.

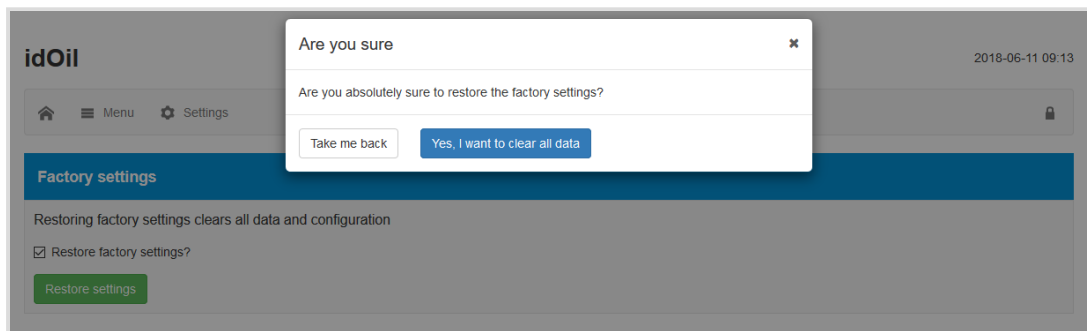

Figure 45. Factory settings - confirm restoration

After this, the system shows the following message: "*Restoring factory settings. Please reload the web page in a few moments. If the WLAN connection is lost, reconnect the device.*"

- ▶ If necessary, establish the WLAN connection in accordance with section *Establishing a WLAN connection*.
- ▶ Configure the system settings and perform sensor identification.

7.3.3.7 WLAN settings

If the WLAN connection is poor, several devices may be using the same WLAN channel.

- ▶ You can change the WLAN channel by using the *WLAN settings* menu to select another channel and pressing the *Save* button.



Figure 46. WLAN settings

- Establish the WLAN connection again according to the instructions in the *Establishing a WLAN connection* section.

7.3.3.8 Low power mode settings

The following settings can be set in the Low power mode settings menu:

Beacon light adjustment (relay state change setting):

With the beacon light adjustment settings, the relay can be set to change its state back and forth during the alarm event. This function can be utilized e.g. when an external beacon light is needed to show the alarm.

Example:

Repeat: 5 s

Duration: 400 ms

The beacon light will flash every 5 seconds and the flash duration is 400 ms.

- Repeat: Sets the interval for the relay to change its state (de-energised or energised) in seconds. You can choose between 2 s, 5 s, 10 s, 30 s and 60 s.
- Duration: Set the length of time the relay remains de-energised. You can choose between 200 ms, 400 ms, 600 ms, 800 ms and 1,000 ms.
- Relay 1 and Relay 2: Off/On. Activation of the relay state change.

- Once you have made the desired changes, press the *Save* button.

Measure interval:

- Repeat: Sets the measurement interval for the idOil device in minutes or hours. You can choose between 10 min, 30 min, 60 min, 2 h, 3 h, 4 h, 6 h, 8 h, 10 h, 12 h or 24 h.
- Start delay: The delay for performing the measurement when the measurement repeat interval is activated. You can choose between 1 s, 2 s, 3 s, 4 s or 5 s.

- Once you have made the desired changes, press the *Save* button.

SMS message receipt interval:

- Repeat: The interval at which the idOil device wakes up to detect whether or not settings messages have been received. You can choose between 12 h, 24 h, 36 h and 48 h. The time is counted from the connection of voltage to the idOil device.

- Once you have made the desired changes, press the *Save* button.

Backlight blinking during alarm:

- Off/On: The flashing function of the idOil device's display backlight can be deactivated to save power.

Battery voltage monitoring:

- Battery voltage level: Battery voltage value in volts
- Monitoring: Off/On.
- Battery low voltage alarm: The voltage limit below which the idOil device triggers a battery voltage alarm. The lowest voltage than can be set is 10.5 V.

► Once you have made the desired changes, press the Save button.

The screenshot displays the 'idOil' web interface with the following settings:

- Low Power Settings** (Header)
- Beacon light adjustment**: Repeat (10s), Duration (600ms), Relay 1 (Off), Relay 2 (Off). Save button.
- Measure interval**: Repeat (10min), Start Delay (5 seconds). Save button.
- SMS receiving interval**: Repeat (12h). Save button.
- Backlight blinking during alarm**: Off/On toggle (On). Save button.
- Battery voltage monitoring**: Battery voltage level (13.364 V), Monitoring (Off/On toggle (On)), Battery low voltage alarm (11.4). Save button.

Figure 47. Low power mode settings

7.3.3.9 3G settings (idOil-30 3G model only, option)

The 3G settings can be found in the M2M settings menu, if the idOil device features a 3G module.

The following settings can be set in the M2M settings menu:

- Receiver phone number (max. 5 phone numbers):
 - ▶ Press the *Add* button.
 - ▶ Enter the phone number.
 - ▶ Press the *Save* button.
- SMS communication centre number:
 - The idOil device detects the SMS communication centre number automatically. If the operator is using multiple communication centre numbers, provide another number and press the *Save* button.
- PIN code:
 - If the PIN code prompt for the SIM card is enabled, enter the PIN code and press the *Save* button. The idOil device will remember the PIN code after this.
- SMS reporting:
 - Enable reporting: No/Yes
 - Frequency: this sets the interval at which the idOil device sends a situation report to the set recipient phone numbers.
 - Sending time: this sets the time at which the situation report should be sent.
- LabkoNet
 - Enable LabkoNet service: Off/On



To activate the LabkoNet service, please contact the Labkotec Oy customer service (info@labkotec.fi).

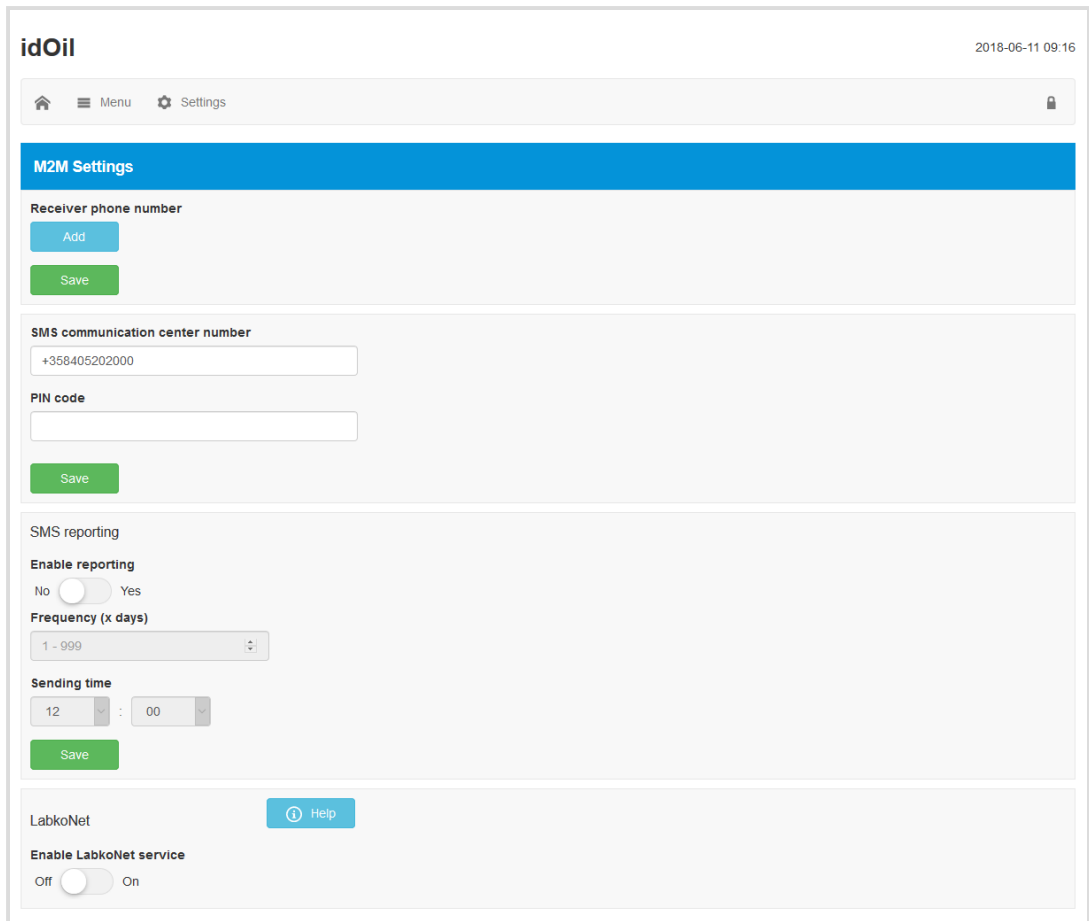

Figure 48. 3G settings

7.4 Operating idOil Solar with mobile phone

i This chapter is relevant to idOil Solar versions with 3G functionality only.

After commissioning the idOil Solar system and installing a SIM card to 3G modem, the user is able to send text messages to the system.

7.4.1 Setting telephone numbers and telephone number queries (TEL)

i A total maximum of five numbers can be set 1–5 numbers at a time. The number is always saved in the first free memory slot.

The format of the telephone number setting command is:

TEL <no1> <no2> <no3> <no4> <no5>

Field legend	
TEL	Telephone number setting command
<no1> <no2> <no3> <no4> <no5>	End user telephone numbers in international format delineated with spaces.

The device responds with a message including the name of the device (if set), the set telephone numbers and the corresponding memory slots in the device memory.

```
TEL <device name if specified>
1: <memory slot 1 telephone no>
.
.
5: <memory slot 5 telephone no>
```

Example:

If the device name has not been defined, no numbers have been set and the entered command is

```
TEL +35840111111 +35840222222 +35840333333
```

the response is:

```
TEL
1: +35840111111
2: +35840222222
3: +35840333333
```

If, after this, the command

```
TEL +35840444444
```

is entered, the response is:

```
TEL
1: +35840111111
2: +35840222222
3: +35840333333
4: +35840444444
```

7.4.2 Name of the device or location (NAME)

 This setting can also be entered via the idOil unit's browser user interface.

It is a good idea to set a unique name for the device or location so that alarm messages, for example, show which device the message is coming from.

The format of the setting command is:

```
NAME <name of the device/location>
```

Field legend	
NAME	Name setting command
<name of the device/location>	Name freely selected by the user – up to 60 characters. The name can also contain spaces.

Example:



► Send the following message to the idOil device:

```
NAME Pirkkala Myllyhaantie
```

The unit responds:

```
NAME Pirkkala Myllyhaantie
```

7.4.3 Time (CLOCK)

-  The time setting is needed if you wish to save log information with actual time stamps or if you want the device to send timed messages to the end user or the LabkoNet server.
-  This setting can also be entered via the idOil unit's browser user interface.

The format of the time setting command is:

CLOCK <yyyy-mm-dd> <hh:mm>

Field legend	
<i>CLOCK</i>	Time setting command and query
<i><yyyy-mm-dd></i>	Year (yyyy), month (mm) and date (dd) separated with a hyphen.
<i><hh:mm></i>	Hours (hh) and minutes (mm) separated with a colon.

Example

Do the following to set the time.

- ▶ Send the following message to the idOil device:

CLOCK 2018-10-23 15:30

The device responds as follows:

CLOCK <device name> 2018-10-23 15:30

In addition to the time, the response includes a possible name set for the device in question.

7.4.4 Timed message interval (TXD)

The idOil unit can be timed to send information on system status and possible alarms to the recipients' phone numbers. The user can define interval in days and the specific time of the message.

The timed alarm information message is described in the section "Alarm status query".

-  This setting can also be entered via the idOil unit's browser user interface.

The command format for setting the timed message interval is as follows:

TXD <nnn> <hh:mm>

Field legend	
<i>TXD</i>	Timed message interval command.
<i><nnn></i>	The timed message interval in days.
<i><hh:mm></i>	The time of the message – hours (hh) and minutes (mm) – separated with a colon.

-  The factory default for the interval and time is 0 00:00. When the interval is set to 0, the timed message is not in use.

Example 1

► Send the following message to the idOil device:

TXD 1 12:00

Device response:

TXD <device name> 1 12:00

The device sends a timed message every day at 12:00.

Example 2

Switching off the timed message

► Send the following message to the idOil device:

TXD 0 00:00

Device response:

TXD <device name> 0

7.4.5 Measurement interval (MI)

An interval can be set for the device, according to which it will wake up from power saving mode, perform sensor measurements and, if necessary, activate the 3G modem to forward the alarm data. After this, the device returns to power saving mode.

- ❗ The factory default for the measurement intervals is 10 (minutes).
- ❗ This setting can also be entered via the idOil unit's browser user interface.

The format of the measurement interval setting command is as follows:

MI <nnn>

Field legend	
MI	Command
<nnnn>	Measurement interval in minutes. Permitted values: 10, 30, 60, 120, 180, 240, 360, 480, 600, 720, 1440

Example:

If Pirkkala Myllyhaantie has been set as the device name and the command

MI 60



is sent, the response is:

MI Pirkkala Myllyhaantie 60

With this setting, the device wakes up to perform sensor measurements every 60 minutes and sends alarm data to the set telephone numbers, if necessary.

7.4.6 Listening interval (LI)

A listening interval can be set for the device, according to which it will wake up from power saving mode, activate the 3G modem and read any possible setting messages and queries that have been sent to it. The device performs any possible setting commands and responds to any possible queries. After this, the device returns to power saving mode.

-  The factory default for the listening interval is 12 hours. The listening takes place every 12 hours from device activation.
-  This setting can also be entered via the idOil unit's browser user interface.

The format of the listening interval setting is as follows:

LI <nn>

Field legend	
LI	Command
<nn>	Listening interval in hours. Permitted values 12, 24, 36, 48.

Example:

If Pirkkala Myllyhaantie has been set as the device name and the command



LI 24

is sent, the response is:

LI Pirkkala Myllyhaantie 24

7.4.7 Operating voltage alarm limit setting (VLIM)

The idOil-30 Battery 3G unit monitors the level of its operating voltage. The device sends an alarm when the voltage drops below the alarm limit setting specified for the operating voltage.

-  The factory default for the alarm limit is 11.4 V.
-  This setting can also be entered via the idOil unit's browser user interface.

The setting command for the operating voltage alarm limit is formatted as follows:

VLIM <xx.x>

Field legend	
VLIM	Setting command for the operating voltage alarm limit
<xx.x>	The desired voltage in volts with one decimal. The integer and decimal are separated with a point. Permitted values: 0 (setting off), 10.5–99.9

-  A 0.2 V hysteresis has been set for alarm removal. In other words, the alarm removal limit is 0.2 V higher than the setpoint. The hysteresis value cannot be changed.

Example:

If the device name has been set as *Pirkkala Myllyhaantie* and the command is:

VLIM 11.8

The response is:

VLIM Pirkkala Myllyhaantie 11.8 V

7.4.8 Alarm information query (M)

To request alarm information from the device,

► send the following message to the idOil device:

M

The device responds as described below by sending the device name, sensor names and alarm or fault information. The information of each sensor input is on a separate row of the message.

```
STATUS <device name>
<sensor input 1 name> / <sensor input 1 alarm or fault status> <yyyy-mm-dd>
<hh:mm>
<sensor input 2 name> / <sensor input 2 alarm or fault status> <yyyy-mm-dd>
<hh:mm>
<sensor input 3 name> / <sensor input 3 alarm or fault status> <yyyy-mm-dd>
<hh:mm>
```

The field legends are listed in the following tables.

Field legend	
STATUS	Heading of command M
<device name>	If a name has been set for the device, it is indicated at the beginning of the message.
<sensor input name> /	The possible descriptive name set by the user for the sensor input and the character “/”.
<alarm text>	Alarm text (standard, cannot be changed, depends on the type of sensor connected to the input): <i>Oil level alarm</i> <i>Sludge level alarm</i> <i>High liquid alarm</i>
<yyyy-mm-dd> <hh:mm>	Alarm time.
<fault alarm text>	Alarm text regarding the fault (standard, cannot be changed, depends on the type of sensor connected to the input): <i>Oil level fault</i> <i>Sludge level fault</i> <i>High liquid fault</i>
<yyyy-mm-dd> <hh:mm>	Alarm time.

Example 1:

```
STATUS Pirkkala Myllyhaantie
Oil level alarm 2018-05-31 13:05
```

Example 2:

If there are no alarms active in the device, it responds with a SYSTEM OK message:

```
STATUS Pirkkala Myllyhaantie  
SYSTEM OK 2018-05-31 13:05
```

7.4.9 Test idOil Solar functions with the sensors

idOil Solar status can be asked by sending the measurement query:

M

to idOil Solar. (Example is from idOil Solar Oil Alarm)

When sensor is connected and totally immersed in water, idOil Solar should reply:

```
"STATUS Airport ABC  
System OK"
```

When sensor is connected and it is either immersed in oil or in air, idOil Solar should reply:

```
"STATUS Airport ABC  
Oil level alarm  
2018-07-13 15:20"
```

When sensor is not connected, idOil Solar should reply:

```
"STATUS Airport ABC  
Oil level Fault  
2018-07-13 15:23"
```

8 Maintenance

-  The operation of the separator system and alarm device must be checked at least every 6 months by experienced personnel.

The following is recommended in conjunction with the inspection:

- functional check of the idOil alarm device with the test function and sensor (see Section *Functional test*)
- sensor cleaning (see Section *Maintenance measures*)

The idOil control unit and sensors do not have wearing or replaceable parts.

The device does not include replaceable fuses.

8.1 Functional test

8.1.1 Test function

The test function creates a test alarm, which is used to ensure the appropriate functioning of the idOil device and any other possible devices or systems controlled by its relays in an alarm situation.

Activating the test function:

- ▶ Press the reset/test button continuously for 3 seconds.

8.1.2 Functional test with sensors

The operation of the idOil device and sensors can be checked comprehensively by simply simulating an actual alarm situation.

The idOil device can be set to test mode by pressing the reset/test button once to activate display and after that again continuously for 10 seconds and release it. The display shows the message *Test mode* and the device enters the continuous measurement mode. The device returns to normal mode automatically in 15 minutes. Alternatively, you can press the reset/test button continuously for 10 seconds and release it.

-  To exit the continuous measurement mode, press the reset/test button for 10 seconds to ensure lower power consumption.

Depending on the sensor type, the functional test can be conducted as follows:

1. idOil-LIQ (high liquid level):
 - ▶ Immerse the sensor in oil or water.
2. idOil-OIL / idOil-OIL-S (oil):
 - ▶ Immerse the sensor in oil. If this is not possible, lift the sensor into the air.
3. idOil-SLU (sludge):
 - ▶ Immerse the sensor in sand or sludge. If this is not possible, lift the sensor into the air.

-  The alarm will be activated after the delay (factory setting: 10 s).

8.2 Maintenance measures

The sensors must be cleaned in conjunction with maintenance inspections. You can clean the sensors with washing up liquid and a washing up brush, for example.



Do not use corrosive substances to clean the sensors.

8.3 Troubleshooting



Adhere to the electrical safety regulations!

PROBLEM:

The display is dark after the reset/test button has been pressed.

Explanation:

The voltage received by the device is too low, or the fuse has blown.

Action:

1. First check that the voltage has not been cut by the mains switch.
2. Measure the voltage from connectors + and -. It should be 11–17 V DC.



EXPLOSION HAZARD!

Observe the installation and maintenance instructions for explosive atmospheres! The measuring device must be Exi classified if the sensor is in an explosive area.

PROBLEM:

Fault alarm on (the backlight of the display is flashing)

Explanation:

The sensor cable is short-circuited, cut or disconnected from the connector. The sensor could also be damaged.

Action:

1. Measure voltage separately from that sensor's sensor connectors. The voltage should be 9.0–11.5 V.
2. If the voltage is correct, measure the current received by the sensor. It should settle between 6.0–8.0 mA within 10 seconds.
3. Reconnect the disconnected wire after the measurement.



The sensor cable wires are not numbered because the voltage polarity (+ or -) makes no difference.

If problems occur, contact Labkotec Oy's service department.

9 Technical and safety data

TECHNICAL SPECIFICATIONS idOil Solar alarm unit	
Dimensions	200 mm x 400 mm x 132 mm (w x h x d)
Enclosure	Material: polycarbonate IP rating: IP43 with two ventilation devices
Weight	8,0 kg
Operating environment	Temperature: -30°C...+60°C Max. elevation above sea level 3,000 m Relative humidity RH 100% Suitable for outdoor use
Battery	12 VDC, 7 Ah lead-acid battery
Power consumption	Max. 10 VA Typical 13,5 mVA (on low-power mode)
Alarm indication	GSM text message AND/OR Xenon beacon AND/OR Potential free relay output (bistable latching relay)
Alarm and Communication Unit	idOil-30 Battery or idOil-30 Battery 3G (See chapter 3. System components)
Sensors	idOil-OIL/idOil-OIL-S and/or idOil-SLU and/or idOil-LIQ (See chapter 3. System components)
ATEX IECEX UKEX	EESF 21 ATEX 024X IECEX EESF 21.0017X CML 21UKEX21351X
Ex classification Special terms (X)	idOil-30 Battery / idOil-30 Battery 3G ⊕ II (1) G [Ex ia Ga] IIB Ta = -30 °C...+60 °C
Exi connection values	Um = 30 V DC, Uo = 14.5 V, Io = 78 mA, Po = 367 mW, R = 243 Ω
Manufacturing year: Please see the serial number on the type plate.	xxxxxxx x xxx xx YY x where YY = manufacturing year (e.g. 18 = 2018)

10 Appendices

10.1 Factory settings for idOil Solar

Every idOil Solar alarm unit has the following settings pre-defined in the factory.

The **Low power settings** of idOil Solar can be changed from idOil-30 Control Unit's settings either through the web user interface or by text messages:

- Beacon light adjustment:
 - Repeat time (factory setting 10 s)
 - Duration (factory setting 600 ms)
 - Beacon connected to relay 1 or relay 2 (factory setting off)
- Measuring interval:
 - Repeat (factory setting 10 min)
 - Start delay (factory setting 5 s)
- Display Backlight blinking during alarm (factory setting ON)
- Battery voltage monitoring:
 - current battery voltage level
 - Monitoring (factory setting ON)
 - Battery low voltage alarm (factory setting 11,4 V)

Most of the factory settings can also be set by text messages.

Command parameters	and	Explanation
DI 1: 1: Oil level sensor. 2: High liquid sensor. 3: Sludge level sensor.		Command sets probe names as follows: Probe nbr 1 is identified as "Oil level sensor". Probe nbr 2 is identified as "High liquid sensor". Probe nbr 3 is identified as "Sludge level sensor" .
VLIM 11.4		Alarm level (in Volts) for minimum battery voltage.
MI 10		Measuring interval idOil Solar wakes up every 10 minutes for 20 seconds from low-power mode to check the status of probes.
LI 12		Listening interval (hours) idOil Solar wakes up from normal (low-power) mode every 12 hours (starting from the time idOil is put to low-power mode) for 2 minutes to check if users have given new SMS commands, and to answer them.

More information about the format of each command and parameter can be found from the following documents:

- idOil-30 Battery, Installation and Operating Instructions (DOC001699).
- idOil-30 Battery 3G, SMS-messages - Commissioning and use (DOC001696).

10.2 Connector Flange for idOil Solar

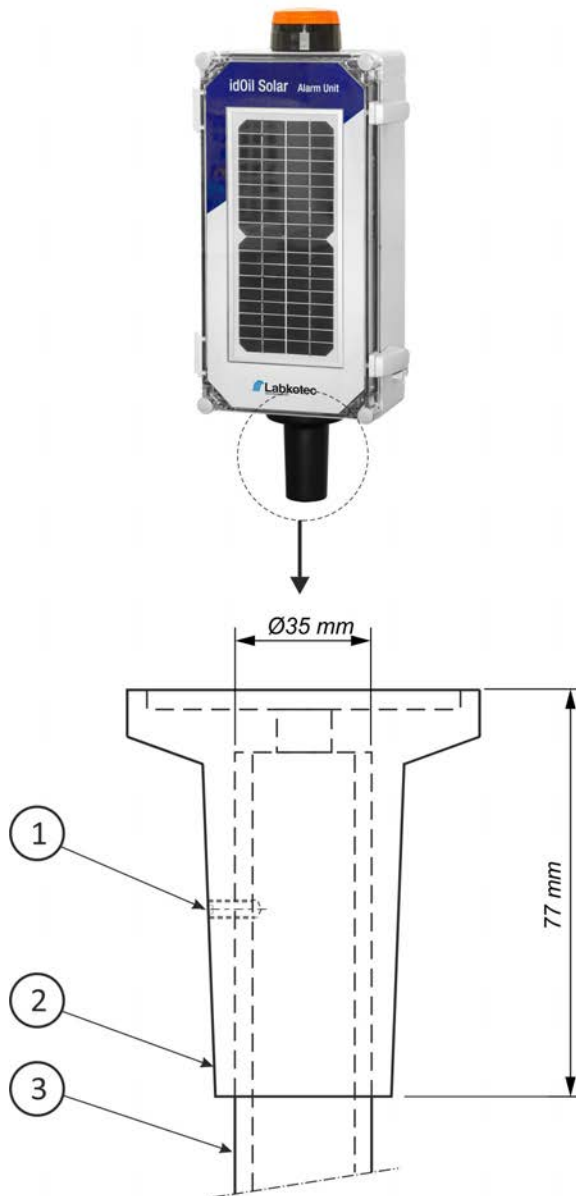

1. M6 x 8 mm locking screw

2. Connector flange

3. Mounting pipe

Drill a 5 - 6 mm hole through the mounting pipe (3) to ensure the idOil Solar is in its correct position.

Position the connector flange locking screw in line with the drilled hole.

Adjust the locking screw until flush with the outer surface of the connector flange.

10.3 idOil Solar Wiring Diagram

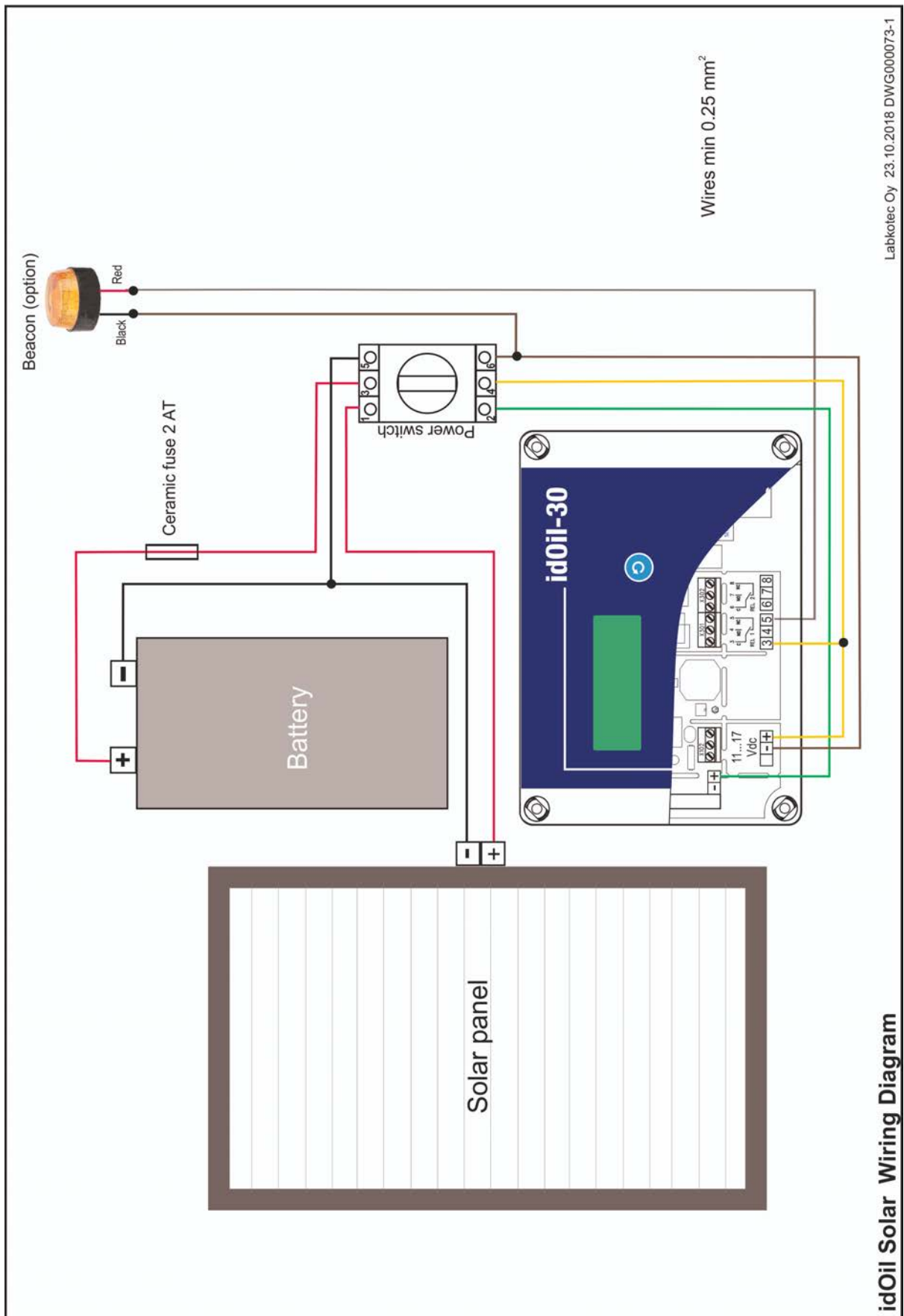

10.4 idOil Solar System Diagram

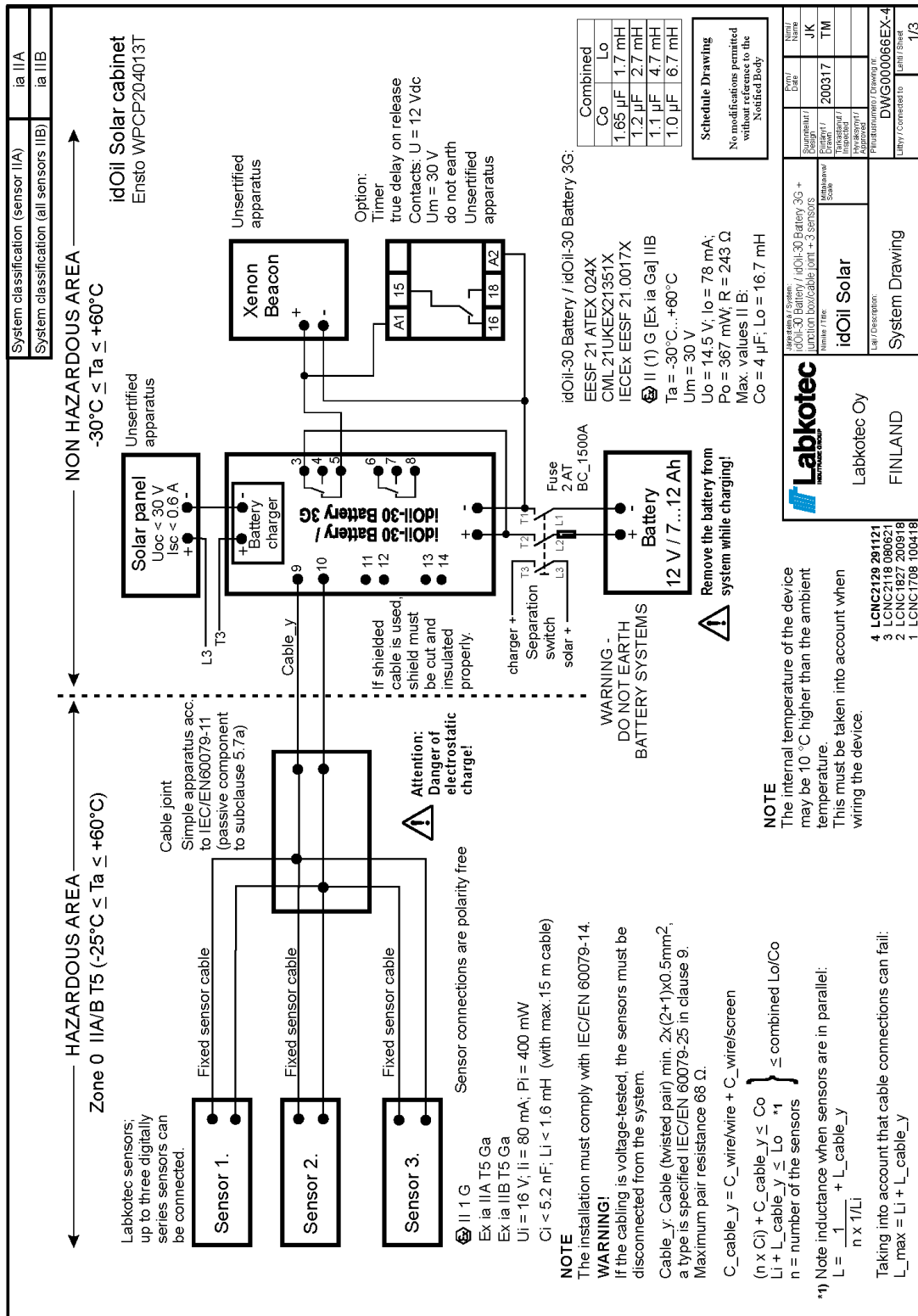

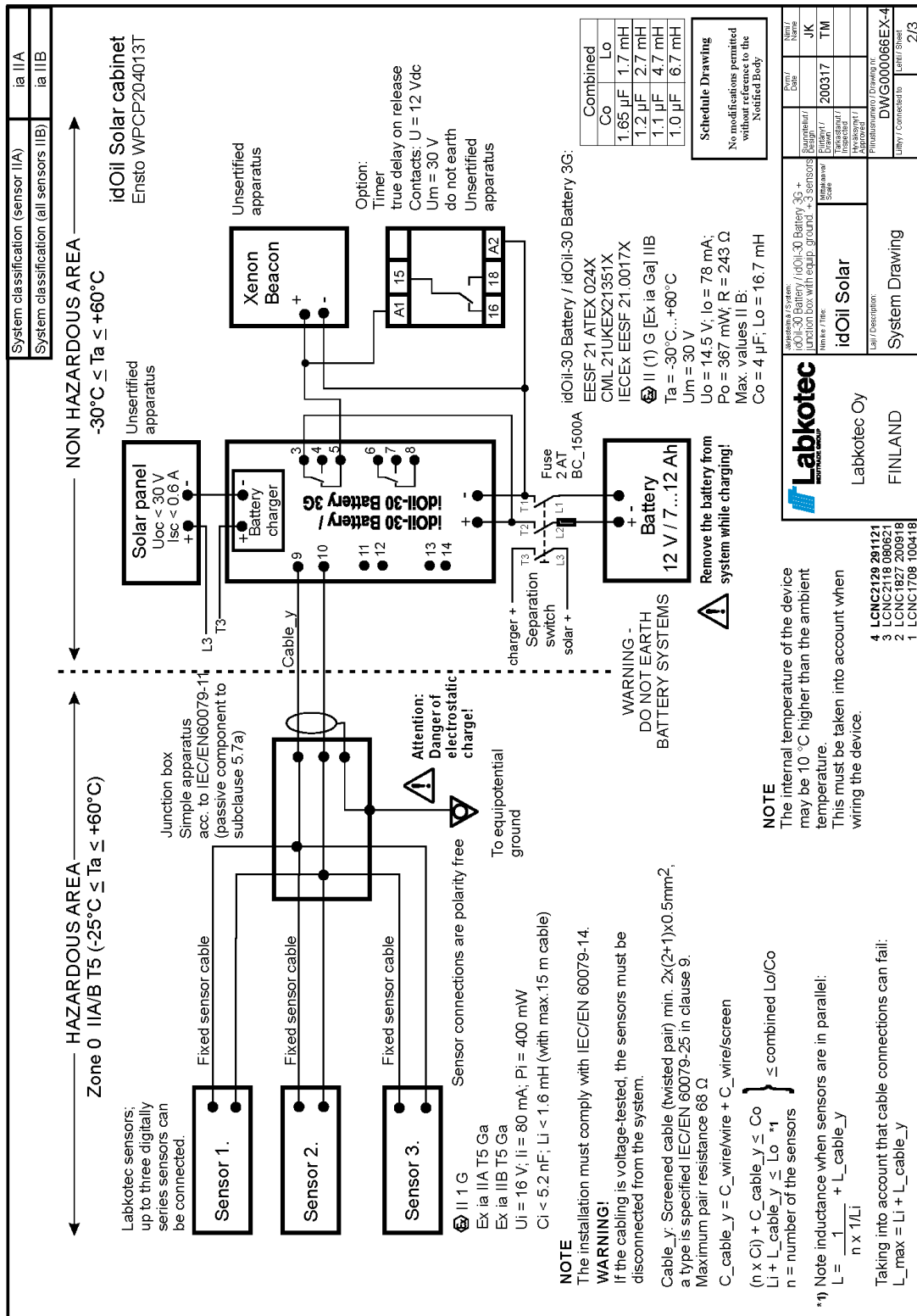

10.5 idOil Solar EU Declaration of Conformity



EU DECLARATION OF CONFORMITY

We hereby declare that the product named below has been designed to comply with the relevant requirements of the referenced directives and standards.

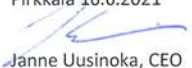
Product	idOil Control Units: idOil-20 idOil-30, idOil-30 3G, idOil-30 Battery, idOil-30 Battery 3G idOil-D30 idOil Solar
Manufacturer	Labkotec Oy Myllyhaantie 6 FI-33960 Pirkkala Finland
Directives	The product is in accordance with the following EU Directives: 2014/30/EU Electromagnetic Compatibility Directive (EMC) 2014/34/EU Equipment for Potentially Explosive Atmospheres Directive (ATEX) 2014/53/EU Radio Equipment Directive (RED) 2014/35/EU Low Voltage Directive (LVD) 2011/65/EU Restriction of Hazardous Substances Directive (RoHS)
Standards	The following standards were applied: EMC: EN IEC 61000-6-2:2019 EN IEC 61000-6-3:2021 EN IEC 61000-3-2:2019 EN 61000-3-3:2013/A1:2019 ATEX: EN IEC 60079-0:2018 EN 60079-11:2012 EN 60079-25:2010/AC:2013 EU-type examination certificate: EESF 21 ATEX 024X. Notified Body: Eurofins Expert Services Ltd, Notified Body number 0537. RED: EN 301 511 v12.5.1 EN 301 908-1 v13.1.1 EN 301 908-2 v13.1.1 EN 300 328 v2.1.1 LVD: EN 61010-1:2010/A1:2019/AC:2019-04 RoHS: EN IEC 63000:2018 The product is CE-marked since 2018.
Signature	This declaration of conformity is issued under the sole responsibility of the manufacturer. Signed for and on behalf of Labkotec Oy. Pirkkala 16.6.2021  Janne Uusinoka, CEO Labkotec Oy

Labkotec Oy | Myllyhaantie 6, FI-33960 Pirkkala, Finland | Tel. +358 29 006 260 | info@labkotec.fi DOC001718-EN-2

10.6 idOil Solar UK Declaration of Conformity



UK DECLARATION OF CONFORMITY

We hereby declare that the product named below has been designed to comply with the relevant requirements of the referenced regulations and standards.

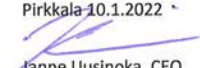
Product	idOil Control Units: idOil-20 idOil-30, idOil-30 3G, idOil-30 Battery, idOil-30 Battery 3G idOil-D30 idOil Solar
Manufacturer	Labkotec Oy Myllyhaantie 6 FI-33960 Pirkkala Finland
Regulations	The product is in accordance with the following UK Regulations: S.I. 2016/1091 Electromagnetic Compatibility Regulations S.I. 2016/1107 Potentially Explosive Atmospheres Regulations S.I. 2017/1206 Radio Equipment Regulations S.I. 2016/1101 Electrical Equipment (Safety) Regulations S.I. 2012/3032 Electrical and Electronic Equipment Regulations
Standards	The following designated standards were applied: EMC: EN IEC 61000-6-2:2019 EN IEC 61000-6-3:2021 EN IEC 61000-3-2:2019 EN 61000-3-3:2013/A1:2019 ATEX: EN IEC 60079-0:2018 EN 60079-11:2012 EN 60079-25:2010/AC:2013 UK-type examination certificate: CML 21UKEX21351X. Approved Body: Eurofins CML, Approved Body number 2503. RED: EN 301 511 v12.5.1 EN 301 908-1 v13.1.1 EN 301 908-2 v13.1.1 EN 300 328 v2.1.1 LVD: EN 61010-1:2010/A1:2019/AC:2019-04 RoHS: EN IEC 63000:2018 The product is UKCA-marked since 2021.
Signature	This declaration of conformity is issued under the sole responsibility of the manufacturer. Signed for and on behalf of Labkotec Oy. Pirkkala 10.1.2022  Janne Uusinoka, CEO Labkotec Oy

Labkotec Oy | Myllyhaantie 6, FI-33960 Pirkkala, Finland | Tel. +358 29 006 260 | info@labkotec.fi DOC001972-EN-0